

2024



Barmesa[®]
Pumps

CONDENSED
CATALOG

barmesapumps.com/US

© 2024 Barmesa Pumps, LLC. All rights reserved.

Any use, distribution and/or reproduction without express authorization is prohibited.

This condensed catalog provided for informational purposes only. All information contained in this document is subject to change without prior notice. Barmesa Pumps, LLC is not responsible for any damage, direct or indirect, derived of the use of this document or related to it.

Credits:

- Landscape photo on cover by *Leo Rivas* - *Unsplash.com*

- Overall design inspired by *oxurra* - *Freepik.com*

BARMESA PUMPS FACTORY WARRANTY

Barmesa Pumps warrants that products of our manufacture will be free of defects in material and workmanship under normal use and service for 18 months from date of manufacture or 12 months from installation date whichever occurs first. This warranty gives you specific legal rights, which vary from state to state.

This warranty is a limited warranty, and no warranty related claims of any nature whatsoever shall be made against Barmesa Pumps, until the ultimate consumer or his/her successor notifies us in writing of the defect and delivers the product and/or defective part(s) freight prepaid to our factory or nearest authorized service station as instructed by Barmesa Pumps. THERE SHALL BE NO FURTHER LIABILITY, WHETHER BASED ON WARRANTY, NEGLIGENCE OR OTHERWISE. PRODUCT SHALL BE EITHER REPLACED OR REPAIRED AT THE ELECTION OF BARMESA PUMPS. Guarantees relating to performance specifications provided in addition to the foregoing material and workmanship warranties on a product manufactured by Barmesa Pumps, if any, are subject to possible factory testing. Any additional guarantees, in the nature of certified performance specifications or time frame must be in writing and such writing must be signed by our authorized factory manager at time of order placement and/or at time of quotation. Due to inaccuracies in field testing and should a conflict arises between the results of field testing conducted by or for the user, Barmesa Pumps reserves the right to have the product returned to our factory for additional testing.

This warranty shall not apply when damage is caused by (1) improper installation, (2) improper voltage, (3) lightning, (4) excessive sand or other abrasive material, (5) corrosion build-up due to excessive chemical content or (6) uncontrollable acts of god. Any modification of the original equipment will also void the warranty. We will not be responsible for loss, damage or labor cost due to interruption of service caused by defective pumps, parts or systems. Barmesa Pumps will not accept charges incurred by others without our prior written approval.

This warranty is void if our inspection reveals the product was used in a manner inconsistent with normal industry practice and/or our specific recommendations. The purchaser is responsible for communication of all necessary information regarding the application and use of the product. UNDER NO CIRCUMSTANCES WILL WE BE RESPONSIBLE FOR ANY OTHER DIRECT OR CONSEQUENTIAL DAMAGES, INCLUDING BUT NOT LIMITED TO TRAVEL EXPENSES, CONTRACTOR FEES, UNAUTHORIZED REPAIR SHOP EXPENSES, LOST PROFITS, LOST INCOME, LABOR CHARGES, DELAYS IN PRODUCTION, IDLE PRODUCTION, WHICH DAMAGES ARE CAUSED BY ANY DEFECTS IN MATERIAL AND/OR WORKMANSHIP AND/OR DAMAGE OR DELAYS IN SHIPMENT. THIS WARRANTY IS EXPRESSLY IN LIEU OF ANY OTHER EXPRESS OR IMPLIED WARRANTY. No rights extended under this warranty shall be assigned to any other person, whether by operation of law or otherwise, without our prior written approval.

IMPORTANT!

If you have a claim under the provision of the warranty, contact Barmesa Pumps or your authorized Barmesa Pumps Distributor:
warranty@barmesapumps.com
www.barmesapumps.com



Sump / Utility Pumps	1
Effluent / Sump / Utility Pumps	2
Submersible Solids Handling Pumps	3
Submersible Stainless Steel Pumps	10
Submersible Grinder Pumps	11
Submersible Cutter Pumps	12
Submersible Explosion-Proof Solids Handling Pumps	13
Submersible Dewatering Stainless Steel Pumps	15
Submersible Dewatering Pumps	16
Submersible Light Slurry Pumps	17
Submersible Slurry Pumps	18
Self Priming Close Coupled Centrifugal Pumps	19
Self Priming Frame Mounted Pumps	20
Self Priming Solids Handling Frame Mounted Pumps	21
Self Priming Solids Handling Engine Driven Pumps	21
End-Suction Centrifugal Close Coupled Pumps	
IA series	22
IB series	25
IC series	26
End-Suction Centrifugal Bearing Frame Mounted Pumps	26
End-Suction Centrifugal Stainless Steel Pumps	
BCS / BCSF series	27
CD series	28
PS series	28
SOX series	29

Vertical In-Line Pumps	
BVL series	30
Vertical Multi-Stage Pumps	
HML series	36
ANSI 911 Series Pumps	38
Slide Rail Couplings	39
Accessories	40
Level Controls	41
Control Panels	42
Control Panels for <i>K</i> series	43
Control Panels Accessories	44
Pump Repair Kits	45

Model	Part no.	HP	Phase	Hz	Volts	RPM	Automatic / Manual	Cord Length	Weight (lb)
BP33	62180001	0.33	1	60	115	3500	M	10'	27
BP33A	62180002	0.33	1	60	115	3500	A	10'	28
BP33A-X	62180003	0.33	1	60	115	3500	A	20'	29
BP33VF	62180004	0.33	1	60	115	3500	VF	10'	28
BP50	62180005	0.5	1	60	115	3500	M	20'	28
BP50A	62180006	0.5	1	60	115	3500	A	20'	29
BP50VF	62180007	0.5	1	60	115	3500	VF	20'	30
2AHS051	62180101	0.5	1	60	115	3500	M	15'	30
2AHS051 (50')	62180101A	0.5	1	60	115	3500	M	50'	35
2AHS051A	62180102	0.5	1	60	115	3500	A	15'	33
2AHS051A (50')	62180102A	0.5	1	60	115	3500	A	50'	38
2AHS101	62180103	1	1	60	115	3500	M	15'	35
2AHS101 (50')	62180103A	1	1	60	115	3500	M	50'	38
2AHS101A	62180104	1	1	60	115	3500	A	15'	36
2AHS101A (50')	62180104A	1	1	60	115	3500	A	50'	38
2AHS103	62180105	1	3	60	230	3500	M	15'	36
2AHS203	62180107	2	3	60	230	3500	M	15'	45

- X = 20 ft power cord | VF = Automatic Vertical Float Switch
- Weight includes packaging.



Model	Part no.	HP	Phase	Hz	Volts	RPM	Automatic / Manual	Cord Length	Weight (lb)
BPEV512	62180201	0.5	1	60	115	3500	M	30'	40
BPEV512A	62180202	0.5	1	60	115	3500	A	30'	50
BPSTEP512	62180203	0.5	1	60	115	3500	M	30'	80
BPSTEP512A	62180204	0.5	1	60	115	3500	A	30'	80
BPSTEP522	62180205	0.5	1	60	230	3500	M	30'	80
BPSTEP1022	62180206	1	1	60	230	3500	M	30'	80

- A = Automatic Float Switch | VF = Automatic Vertical Float Switch
- Weight includes packaging.

Effluent, Sump & Utility Pumps

Model	Part no.	HP	Phase	Hz	Volts	RPM	Automatic / Manual	Cord Length	Weight (lb)
2SVEN051A	70090031	0.5	1	60	115	3450	A	20'	37
2SVEN101A	70090032	1	1	60	115	3450	A	20'	44
2SVEN102A	70090033	1	1	60	230	3450	A	20'	44
2SVEN103	70090035	1	3	60	230	3450	M	20'	43

- A = Automatic Float Switch
- Weight includes packaging.



2" Single Seal Pumps

Model	Part no.	HP	Phase	Hz	Volts	RPM	Automatic / Manual	Cord Length	Weight (lb)
2BSE411	62180401	0.4	1	60	115	1750	M	30'	55
2BSE411A	62180402	0.4	1	60	115	1750	A	30'	55
2BSE421	62180403	0.4	1	60	230	1750	M	30'	55
2BSE511A	62180404	0.5	1	60	115	1750	A	30'	55
2SEV512	62180405	0.5	1	60	115	3500	M	30'	55
2SEV512A	62180406	0.5	1	60	115	3500	A	30'	55
2SEV512VF	62180407	0.5	1	60	115	3500	VF	30'	55

- A = Automatic Float Switch | VF = Automatic Vertical Float Switch
- Weight includes packaging.

2" Heavy Duty, Single Seal Pumps

Model	Part no.	HP	Phase	Hz	Volts	RPM	Automatic / Manual	Cord Length	Weight (lb)
2BSE51SS	62180501	0.5	1	60	115	1750	M	30'	91
2BSE51A	62180501A	0.5	1	60	115	1750	A	30'	93
2BSE52SS	62180502	0.5	1	60	200/230	1750	M	30'	85
2BSE53SS	62180503	0.5	3	60	200/230	1750	M	30'	85
2BSE54SS	62180504	0.5	3	60	460	1750	M	30'	86
2BSE72SS	62180505	0.75	1	60	230	1750	M	30'	90
2BSE73SS	62180506	0.75	3	60	200/230	1750	M	30'	86
2BSE74SS	62180507	0.75	3	60	460	1750	M	30'	87

- Ø3" discharge flange is also available for these models.
- Weight includes packaging.



3" Single Seal Pumps

Model	Part no.	HP	Phase	Hz	Volts	RPM	Automatic / Manual	Cord Length	Weight (lb)
2BSE102SS/3BSE102SS**	62180508	1	1	60	230	1750	M	30'	105
2BSE103SS/3BSE103SS**	62180509	1	3	60	230	1750	M	30'	105
2BSE104SS/3BSE104SS**	62180510	1	3	60	460	1750	M	30'	105
3BSE152SS	62170010	1.5	1	60	230	1750	M	25'	229
3BSE153SS	62170011	1.5	3	60	230	1750	M	25'	205
3BSE154SS	62170012	1.5	3	60	460	1750	M	25'	205
3BSE202SS	62170013	2	1	60	230	1750	M	25'	225
3BSE203SS	62170014	2	3	60	230	1750	M	25'	205
3BSE204SS	62170015	2	3	60	460	1750	M	25'	214
3BSE302SS	62170016	3	1	60	230	1750	M	25'	228
3BSE303SS	62170017	3	3	60	230	1750	M	25'	233
3BSE304SS	62170018	3	3	60	460	1750	M	25'	233

** Ø2" discharge flange is also available for these models.

• Weight includes packaging.

3" Sewage, Dual Seal Pumps

Model	Part no.	HP	Phase	Hz	Volts	RPM	Automatic / Manual	Cord Length	Weight (lb)
3BWSE202DS	62170169	2	1	60	230	1750	M	40'	225
3BWSE203DS	62170161	2	3	60	230	1750	M	40'	194
3BWSE204DS	62170162	2	3	60	460	1750	M	40'	194
3BWSE302DS	62170167	3	1	60	230	1750	M	40'	225
3BWSE303DS	62170163	3	3	60	230	1750	M	40'	201
3BWSE304DS	62170164	3	3	60	460	1750	M	40'	201
3BWSE503DS	62170165	5	3	60	230	1750	M	40'	205
3BWSE504DS	62170166	5	3	60	460	1750	M	40'	205

• Weight includes packaging.

4" Single Seal Pumps

Model	Part no.	HP	Phase	Hz	Volts	RPM	Automatic / Manual	Cord Length	Weight (lb)
4BSE302SS	62170101	3	1	60	230	1750	M	40'	245
4BSE303SS	62170102	3	3	60	230	1750	M	40'	230
4BSE304SS	62170103	3	3	60	460	1750	M	40'	230
4BSE502SS	62170104	5	1	60	230	1750	M	40'	245
4BSE503SS	62170105	5	3	60	230	1750	M	40'	230
4BSE504SS	62170106	5	3	60	460	1750	M	40'	230

• Weight includes packaging.

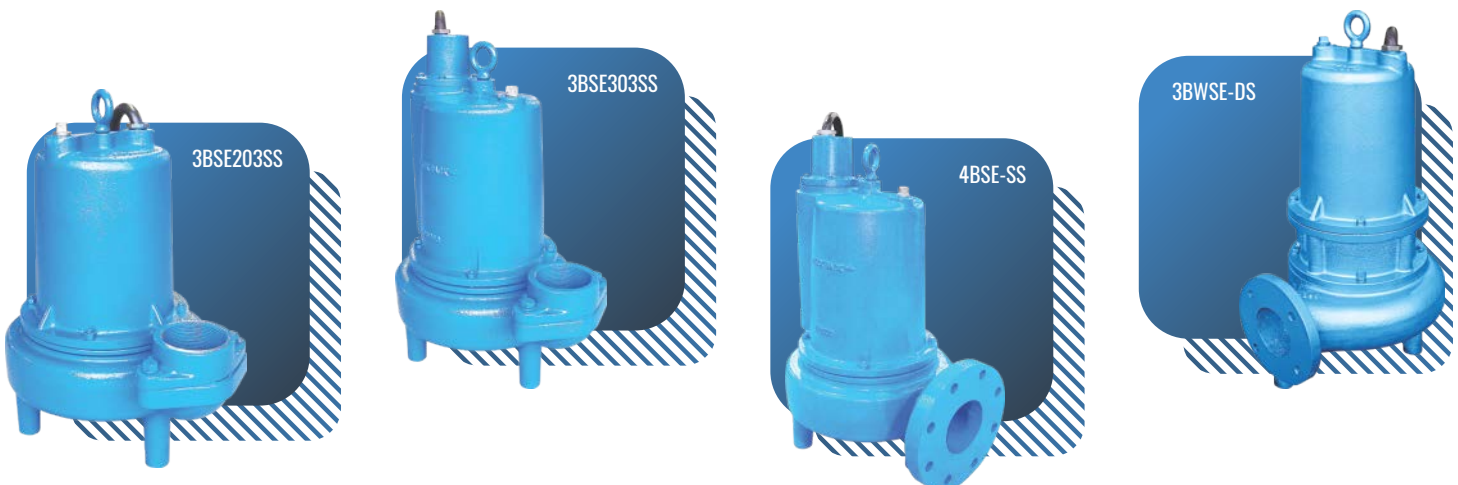

4" Dual Seal Pumps

Model	Part no.	HP	Phase	Hz	Volts	RPM	Automatic / Manual	Cord Length	Weight (lb)
4BWE202DS	62170160D	2	1	60	230	1750	M	40'	245
4BWE203DS	62170151	2	3	60	230	1750	M	40'	200
4BWE204DS	62170152	2	3	60	460	1750	M	40'	200
4BWE302DS	62170159	3	1	60	230	1750	M	40'	247
4BWE303DS	62170153	3	3	60	230	1750	M	40'	205
4BWE304DS	62170154	3	3	60	460	1750	M	40'	205
4BWE503DS	62170155	5	3	60	230	1750	M	40'	210
4BWE504DS	62170156	5	3	60	460	1750	M	40'	210
4BWE753DS	62170157	7.5	3	60	230	1750	M	40'	225
4BWE754DS	62170158	7.5	3	60	460	1750	M	40'	225

• Weight includes packaging.

4" Double Seal Pumps

Model	Part no.	HP	Phase	Hz	Volts	RPM	Automatic / Manual	Cord Length	Weight (lb)
4BSE452DS	62170121	4.5	1	60	230	1750	M	40'	432
4BSE453DS	62170122	4.5	3	60	230	1750	M	40'	430
4BSE454DS	62170123	4.5	3	60	460	1750	M	40'	432
4BSE752DS	62170124	7.5	1	60	230	1750	M	40'	434
4BSE753DS	62170125	7.5	3	60	230	1750	M	40'	430
4BSE754DS	62170126	7.5	3	60	460	1750	M	40'	445
4BSE1133DS	62170127	11.3	3	60	230	1750	M	40'	430
4BSE1134DS	62170128	11.3	3	60	460	1750	M	40'	430
4BSE1503DS	62170129	15	3	60	230	1750	M	40'	430
4BSE1504DS	62170130	15	3	60	460	1750	M	40'	430

• Weight includes packaging.

4" High Head, Double Seal Pumps

Model	Part no.	HP	Phase	Hz	Volts	RPM	Automatic / Manual	Cord Length	Weight (lb)
4BSE753HLDS	62170141	7.5	3	60	230	1750	M	40'	420
4BSE754HLDS	62170142	7.5	3	60	460	1750	M	40'	430
4BSE1133HLDS	62170143	11.3	3	60	230	1750	M	40'	423
4BSE1134HLDS	62170144	11.3	3	60	460	1750	M	40'	430
4BSE1503HLDS	62170145	15	3	60	230	1750	M	40'	430
4BSE1504HLDS	62170146	15	3	60	460	1750	M	40'	430

• Weight includes packaging.



6" Double Seal Pumps

Model	Part no.	HP	Phase	Hz	Volts	RPM	Automatic / Manual	Cord Length	Weight (lb)
6BSE9036LDS	62170271	9	3	60	230	1150	M	25'	1170
6BSE9046LDS	62170272	9	3	60	460	1150	M	25'	1170
6BSE12036LDS	62170273	12	3	60	230	1150	M	25'	1160
6BSE12046LDS	62170274	12	3	60	460	1150	M	25'	1160
6BSE18036LDS	62170275	18	3	60	230	1150	M	25'	1190
6BSE18046LDS	62170276	18	3	60	460	1150	M	25'	917
6BSE24036LDS	62170277	24	3	60	230	1150	M	25'	961
6BSE24046LDS	62170278	24	3	60	460	1150	M	25'	1300
6BSE30036LDS	62170279	30	3	60	230	1150	M	25'	1008
6BSE30046LDS	62170280	30	3	60	460	1150	M	25'	1363
6BSE18034LDS	62170206	18	3	60	230	1750	M	25'	1180
6BSE18044LDS	62170207	18	3	60	460	1750	M	25'	1160
6BSE24034LDS	62170210	24	3	60	230	1750	M	25'	1204
6BSE24044LDS	62170211	24	3	60	460	1750	M	25'	1204
6BSE30034LDS	62170214	30	3	60	230	1750	M	25'	1250
6BSE30044LDS	62170215	30	3	60	460	1750	M	25'	1250
6BSE36034LDS	62170231	36	3	60	230	1750	M	25'	1135
6BSE36044LDS	62170232	36	3	60	460	1750	M	25'	1210
6BSE48044LDS	62170220	48	3	60	460	1750	M	25'	1300

• Weight includes packaging.

6" High Head, Double Seal Pumps

Model	Part no.	HP	Phase	Hz	Volts	RPM	Automatic / Manual	Cord Length	Weight (lb)
6BSE30034HLDS	62170301	30	3	60	230	1750	M	25'	957
6BSE30044HLDS	62170302	30	3	60	460	1750	M	25'	957
6BSE36034HLDS	62170303	36	3	60	230	1750	M	25'	963
6BSE36044HLDS	62170304	36	3	60	460	1750	M	25'	963
6BSE48044HLDS	62170305	48	3	60	460	1750	M	25'	974

• Weight includes packaging.

8" High Head, Double Seal Pumps

Model	Part no.	HP	Phase	Hz	Volts	RPM	Automatic / Manual	Cord Length	Weight (lb)
8BSE36036HLDS	62170320	36	3	60	230	1150	M	25'	992
8BSE36046HLDS	62170321	36	3	60	460	1150	M	25'	992
8BSE48046HLDS	62170323	48	3	60	460	1150	M	25'	1014

• Weight includes packaging.



6BSE-LDS



6BSE-HLDS



8BSE-HLDS



Model	Part no.	HP	Ph	Hz	Volts	RPM	Frame	Weight (lb)
4SWL15034DS	62172001	15	3	60	208/230	1750	210	492
4SWL15044DS	62172002	15	3	60	460	1750	210	492
4SWL20034DS	62172003	20	3	60	208/230	1750	250	602
4SWL20044DS	62172004	20	3	60	460	1750	250	602
4SWL25034DS	62172005	25	3	60	208/230	1750	250	620
4SWL25044DS	62172006	25	3	60	460	1750	250	620
4SWL30034DS	62172007	30	3	60	208/230	1750	250	640
4SWL30044DS	62172008	30	3	60	460	1750	250	640
4SWL40044DS	62172010	40	3	60	460	1750	250	670
4SWL7536DS	62172011	7.5	3	60	208/230	1150	250	568
4SWL7546DS	62172012	7.5	3	60	460	1150	250	568
4SWL10036DS	62172013	10	3	60	208/230	1150	250	585
4SWL10046DS	62172014	10	3	60	460	1150	250	585
4SWL15036DS	62172015	15	3	60	208/230	1150	250	610
4SWL15046DS	62172016	15	3	60	460	1150	250	610

Model	Part no.	HP	Ph	Hz	Volts	RPM	Frame	Weight (lb)
4SWM20034DS	62172019	20	3	60	208/230	1750	250	615
4SWM20044DS	62172020	20	3	60	460	1750	250	615
4SWM25034DS	62172021	25	3	60	208/230	1750	250	633
4SWM25044DS	62172022	25	3	60	460	1750	250	633
4SWM30034DS	62172023	30	3	60	208/230	1750	250	653
4SWM30044DS	62172024	30	3	60	460	1750	250	653
4SWM40044DS	62172025	40	3	60	460	1750	250	683
4SWM50044DS	62172026	50	3	60	460	1750	320	760

Model	Part no.	HP	Ph	Hz	Volts	RPM	Frame	Weight (lb)
4SWH20034DS	62172029	20	3	60	208/230	1750	250	615
4SWH20044DS	62172030	20	3	60	460	1750	250	615
4SWH25034DS	62172031	25	3	60	208/230	1750	250	633
4SWH25044DS	62172032	25	3	60	460	1750	250	633
4SWH30034DS	62172033	30	3	60	208/230	1750	250	653
4SWH30044DS	62172034	30	3	60	460	1750	250	653
4SWH40044DS	62172035	40	3	60	460	1750	250	683
4SWH50044DS	62172036	50	3	60	460	1750	320	760
4SWH60044DS	62172037	60	3	60	460	1750	320	782
4SWH75044DS	62172038	75	3	60	460	1750	320	806
4SWH100044DS	62172039	100	3	60	460	1750	400	927
4SWH10036DS	62172042	10	3	60	208/230	1150	250	598
4SWH10046DS	62172043	10	3	60	460	1150	250	598
4SWH15036DS	62172044	15	3	60	208/230	1150	250	623
4SWH15046DS	62172045	15	3	60	460	1150	250	623
4SWH20036DS	62172046	20	3	60	208/230	1150	250	642
4SWH20046DS	62172047	20	3	60	460	1150	250	642
4SWH25036DS	62172048	25	3	60	208/230	1150	320	719
4SWH25046DS	62172049	25	3	60	460	1150	320	719
4SWH30036DS	62172050	30	3	60	208/230	1150	320	740
4SWH30046DS	62172051	30	3	60	460	1150	320	740
4SWH40046DS	62172052	40	3	60	460	1150	320	762



Model	Part no.	HP	Ph	Hz	Volts	RPM	Frame	Weight (lb)
6SWL15034DS	62172101	15	3	60	208/230	1750	210	692
6SWL15044DS	62172102	15	3	60	460	1750	210	692
6SWL20034DS	62172103	20	3	60	208/230	1750	250	823
6SWL20044DS	62172104	20	3	60	460	1750	250	823
6SWL25034DS	62172105	25	3	60	208/230	1750	250	847
6SWL25044DS	62172106	25	3	60	460	1750	250	847
6SWL7536DS	62172107	7.5	3	60	208/230	1150	250	790
6SWL7546DS	62172108	7.5	3	60	460	1150	250	790
6SWL10036DS	62172109	10	3	60	208/230	1150	250	800
6SWL10046DS	62172110	10	3	60	460	1150	250	800

Model	Part no.	HP	Ph	Hz	Volts	RPM	Frame	Weight (lb)
6SWM25034DS	62172111	25	3	60	208/230	1750	250	985
6SWM25044DS	62172112	25	3	60	460	1750	250	985
6SWM30044DS	62172114	30	3	60	460	1750	250	1016
6SWM40044DS	62172116	40	3	60	460	1750	250	1046
6SWM50044DS	62172118	50	3	60	460	1750	320	1123
6SWM10036DS	62172119	10	3	60	208/230	1150	250	815
6SWM10046DS	62172120	10	3	60	460	1150	250	815
6SWM15036DS	62172121	15	3	60	208/230	1150	250	840
6SWM15046DS	62172122	15	3	60	460	1150	250	840

Model	Part no.	HP	Ph	Hz	Volts	RPM	Frame	Weight (lb)
6SWH25034DS	62172123	25	3	60	208/230	1750	250	985
6SWH25044DS	62172124	25	3	60	460	1750	250	985
6SWH30034DS	62172125	30	3	60	208/230	1750	250	1016
6SWH30044DS	62172126	30	3	60	460	1750	250	1016
6SWH40044DS	62172127	40	3	60	460	1750	250	1046
6SWH50044DS	62172128	50	3	60	460	1750	320	1123
6SWH60044DS	62172129	60	3	60	460	1750	320	1156
6SWH75044DS	62172130	75	3	60	460	1750	320	1191
6SWH100044DS	62172131	100	3	60	460	1750	400	1226
6SWH125044DS	62172132	125	3	60	460	1750	400	1263
6SWH7536DS	62172133	7.5	3	60	208/230	1150	250	798
6SWH7546DS	62172134	7.5	3	60	460	1150	250	798
6SWH10036DS	62172135	10	3	60	208/230	1150	250	815
6SWH10046DS	62172136	10	3	60	460	1150	250	815
6SWH15036DS	62172137	15	3	60	208/230	1150	250	840
6SWH15046DS	62172138	15	3	60	460	1150	250	840
6SWH20036DS	62172139	20	3	60	208/230	1150	250	865
6SWH20046DS	62172140	20	3	60	460	1150	250	865
6SWH25036DS	62172141	25	3	60	208/230	1150	320	955
6SWH25046DS	62172142	25	3	60	460	1150	320	955
6SWH30036DS	62172143	30	3	60	208/230	1150	320	983
6SWH30046DS	62172144	30	3	60	460	1150	320	983
6SWH40036DS	62172145	40	3	60	460	1150	320	1013
6SWH40046DS	62172146	40	3	60	460	1150	320	1013



Model	Part no.	HP	Ph	Hz	Volts	RPM	Frame	Weight (lb)
8SWL25034DS	62172201	25	3	60	208/230	1750	250	-
8SWL25044DS	62172202	25	3	60	460	1750	250	-
8SWL30034DS	62172203	30	3	60	208/230	1750	250	-
8SWL30044DS	62172204	30	3	60	460	1750	250	-
8SWL40044DS	62172205	40	3	60	460	1750	250	-
8SWL50044DS	62172206	50	3	60	460	1750	320	-
8SWL60044DS	62172207	60	3	60	460	1750	320	-
8SWL75044DS	62172208	75	3	60	460	1750	320	-
8SWL100044DS	62172209	100	3	60	460	1750	400	-
8SWL7536DS	62172210	7.5	3	60	208/230	1150	250	-
8SWL7536DS	62172211	7.5	3	60	460	1150	250	-
8SWL10036DS	62172212	10	3	60	208/230	1150	250	-
8SWL10046DS	62172213	10	3	60	460	1150	250	-
8SWL15036DS	62172214	15	3	60	208/230	1150	250	-
8SWL15046DS	62172215	15	3	60	460	1150	250	-
8SWL20036DS	62172216	20	3	60	208/230	1150	250	-
8SWL20046DS	62172217	20	3	60	460	1150	250	-
8SWL25036DS	62172218	25	3	60	208/230	1150	320	-
8SWL25046DS	62172219	25	3	60	460	1150	320	-



Model	Part no.	HP	Ph	Hz	Volts	RPM	Frame	Weight (lb)
12SWL40046DS	62172315	40	3	60	460	1750	320	-
12SWL50046DS	62172316	50	3	60	460	1750	320	-

Pump leg kits for SW series pumps

Part no.	Description
33010410	Pump leg kit for 4SW / 6SW - 3.25"
33010411	Pump leg kit for 8SW - 6.5"

- Each kit includes three supports with their respective socket screws

2", 3" & 4" Sewage, Double Seal, Vortex Impeller, 316 SS Pumps

Model	Part no.	HP	Phase	Hz	Volts	RPM	Automatic / Manual	Cord Length	Weight (lb)
2BSV051DS	72090061	0.5	1	60	115	3450	M	33'	31
2BSV054DS	72090081	0.5	3	60	460	3450	M	33'	31
2BSV101DS	72090062	1	1	60	115	3450	M	33'	42
2BSV102DS	72090063	1	1	60	230	3450	M	33'	42
2BSV103DS	72090064	1	3	60	230	3450	M	33'	42
2BSV104DS	72090065	1	3	60	460	3450	M	33'	42
2BSV202DS	72090066	2	1	60	230	3450	M	33'	81
2BSV203DS	72090071	2	3	60	230	3450	M	33'	81
2BSV204DS	72090083	2	3	60	460	3450	M	33'	81
2BSV303DS	72090073	3	3	60	230	3450	M	33'	84
2BSV304DS	72090084	3	3	60	460	3450	M	33'	85
3BSV503DS	72090075	5	3	60	230	3450	M	33'	150
3BSV504DS	72090085	5	3	60	460	3450	M	33'	150
3BSV753DS	72090077	7.5	3	60	230	3450	M	33'	161
3BSV754DS	72090078	7.5	3	60	460	3450	M	33'	161
4BSV1003DS	72090079	10	3	60	230	3450	M	47'	157
4BSV1004DS	72090080	10	3	60	460	3450	M	47'	157

• Weight includes packaging.

Slide Rail Coupling 316 SS

Model	Part no.	Size	Rails	Coupling	Check Valve	Weight (lb)
SQM-2	72090091	2 & 3	-	w/ upper guide bracket	No	33



Model	Part no.	HP	Phase	Hz	Volts	RPM	Automatic / Manual	Cord Length	Weight (lb)
BGP202DS ¹	72100101	2	1	60	208/230	3500	M	30'	104
BGP203DS	72100102	2	3	60	208/230	3500	M	30'	104
BGP204DS	72100103	2	3	60	460	3500	M	30'	105
BGP302DS	62170605	3	1	60	230	3500	M	40'	215
BGP303DS	62170606	3	3	60	230	3500	M	40'	205
BGP304DS	62170607	3	3	60	460	3500	M	40'	211
BGP502DS	62170608	5	1	60	230	3500	M	40'	230
BGP503DS	62170609	5	3	60	230	3500	M	40'	230
BGP504DS	62170610	5	3	60	460	3500	M	40'	230
BGP753DS	62170611	7.5	3	60	230	3500	M	40'	230
BGP754DS	62170612	7.5	3	60	460	3500	M	40'	230
BGPC201DS	-	1	1	60	230	3500	M	-	-
BGPC201DSA	-	1	1	60	230	3500	A	-	-
BGPC202DS	72100104	2	1	60	230	3500	M	30'	105
BGPC202DSA ²	72100105	2	1	60	230	3500	A	30'	105
BGPH302DS	62170621	3	1	60	230	3500	M	40'	230
BGPH303DS	62170622	3	3	60	230	3500	M	40'	230
BGPH304DS	62170623	3	3	60	460	3500	M	40'	230
BGPH502DS	62170624	5	1	60	230	3500	M	40'	230
BGPH503DS	62170625	5	3	60	230	3500	M	40'	230
BGPH504DS	62170626	5	3	60	460	3500	M	40'	230
BGPH503DS-208V	62170632G	5	3	60	208	3500	M	40'	230
BGP503DS-208V	62170632	5	3	60	208	3500	M	40'	230
BGPH303DS-208V	62170631B	3	3	60	208	3500	M	40'	230
BGP303DS-208V	62170631	3	3	60	208	3500	M	40'	230
BGPH753DS	62170627	7.5	3	60	230	3500	M	40'	240
BGPH754DS	62170628	7.5	3	60	460	3500	M	40'	240

• Weight includes packaging.

¹ Includes the capacitor and relay kit with the pump

² Includes the level control with the pump

Capacitor Kits

Model	Part no.	HP	Phase	Hz	Volts	RPM	On Panel	Loose Items	Weight (lb)
4BSE452DS	62350007	4.5	1	60	230	1750	x	-	-
4BSE752DS	62350002	7.5	1	60	230	1750	x	-	-
BGP302DS	62350004	3	1	60	230	3450	x	-	-
BGP502DS	62350005	5	1	60	230	3450	x	-	-
BGP202DS	80020118B	2	1	60	230	3450	-	x	-
BGPC202DS	80020118	2	1	60	230	3450	-	x	-

Grinder Pump Stand

Model	Part no.	Material
BGP-DS	30402051	Stainless steel base plate w/ hardware
BGPH-DS	30402051B	Stainless steel base plate w/ hardware



BGP-DS (2 HP)



BGP-DS (3 HP)



BGPH-DS (3 HP)



GRINDER PUMP STAND

4" Discharge Pumps

Model	Part no.	HP	Phase	Hz	Volts	RPM	Automatic / Manual	Cord Length	Weight (lb)
CUT303	70090201	3	3	60	230	1750	M	40'	211
CUT304	70090203	3	3	60	460	1750	M	40'	165
CUT503	70090206	5	3	60	230	1750	M	40'	250
CUT504	70090208	5	3	60	460	1750	M	40'	250
CUT753	70090209	7.5	3	60	230	1750	M	40'	365
CUT754	70090210	7.5	3	60	460	1750	M	40'	365
CUT1003	70090211	10	3	60	230	1750	M	40'	445
CUT1004	70090212	10	3	60	460	1750	M	40'	410

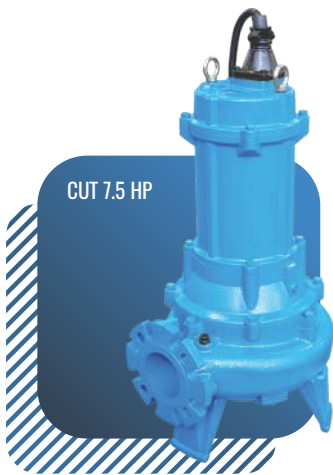
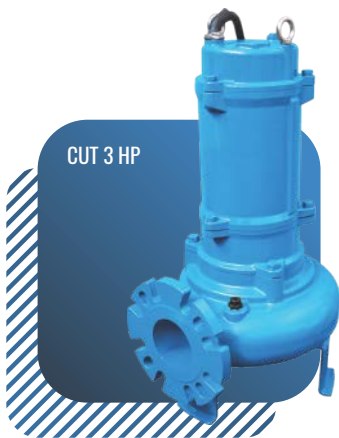

4" Sewage, Double Seal Pumps w/ Explosion Proof Motors

Model	Part no.	HP	Phase	Hz	Volts	RPM	Automatic / Manual	Cord Length	Weight (lb)
4XBSE5036ADS	-	5	3	60	230	1150	M	25'	-
4XBSE5046ADS	-	5	3	60	460	1150	M	25'	-
4XBSE7536ADS	-	7.5	3	60	230	1150	M	25'	-
4XBSE7564ADS	-	7.5	3	60	460	1150	M	25'	-
4XBSE5034ADS	-	5	3	60	230	1750	M	25'	-
4XBSE5044ADS	-	5	3	60	460	1750	M	25'	-
4XBSE7534ADS	-	7.5	3	60	230	1750	M	25'	-
4XBSE7544ADS	-	7.5	3	60	460	1750	M	25'	-
4XBSE10034ADS	-	10	3	60	230	1750	M	25'	-
4XBSE10044ADS	-	10	3	60	460	1750	M	25'	-
4XBSE15034ADS	-	15	3	60	230	1750	M	25'	-
4XBSE15044ADS	-	15	3	60	460	1750	M	25'	-
4XBSE7534HADS	-	7.5	3	60	230	1750	M	25'	-
4XBSE7544HADS	-	7.5	3	60	460	1750	M	25'	-
4XBSE10034HADS	-	10	3	60	230	1750	M	25'	-
4XBSE10044HADS	-	10	3	60	460	1750	M	25'	-
4XBSE15034HADS	-	15	3	60	230	1750	M	25'	-
4XBSE15044HADS	-	15	3	60	460	1750	M	25'	-

6" Sewage, Double Seal Pumps w/ Explosion Proof Motors

Model	Part no.	HP	Phase	Hz	Volts	RPM	Automatic / Manual	Cord Length	Weight (lb)
6XBSE15036ADS	-	15	3	60	230	1150	M	25'	-
6XBSE15046ADS	-	15	3	60	460	1150	M	25'	-
6XBSE20036ADS	-	20	3	60	230	1150	M	25'	-
6XBSE20046ADS	-	20	3	60	460	1150	M	25'	-
6XBSE25036ADS	-	25	3	60	230	1150	M	25'	-
6XBSE25046ADS	-	25	3	60	460	1150	M	25'	-
6XBSE15034ADS	-	15	3	60	230	1750	M	25'	-
6XBSE15044ADS	-	15	3	60	460	1750	M	25'	-
6XBSE20034ADS	-	20	3	60	230	1750	M	25'	-
6XBSE20044ADS	-	20	3	60	460	1750	M	25'	-
6XBSE25034ADS	-	25	3	60	230	1750	M	25'	-
6XBSE25044ADS	-	25	3	60	460	1750	M	25'	-
6XBSE30034ADS	-	30	3	60	230	1750	M	25'	-
6XBSE30044ADS	-	30	3	60	460	1750	M	25'	-
6XBSE40034ADS	-	40	3	60	230	1750	M	25'	-
6XBSE40044ADS	-	40	3	60	460	1750	M	25'	-
6XBSE50034ADS	-	50	3	60	230	1750	M	25'	-
6XBSE50044ADS	-	50	3	60	460	1750	M	25'	-
6XBSE60034ADS	-	60	3	60	230	1750	M	25'	-
6XBSE60044ADS	-	60	3	60	460	1750	M	25'	-

6" Sewage, Double Seal Pumps w/ Explosion Proof Motors

Model	Part no.	HP	Phase	Hz	Volts	RPM	Automatic / Manual	Cord Length	Weight (lb)
6XBSE15036HADS	-	15	3	60	230	1150	M	25'	-
6XBSE15046HADS	-	15	3	60	460	1150	M	25'	-
6XBSE20036HADS	-	20	3	60	230	1150	M	25'	-
6XBSE20046HADS	-	20	3	60	460	1150	M	25'	-
6XBSE30036HADS	-	30	3	60	230	1150	M	25'	-
6XBSE30046HADS	-	30	3	60	460	1150	M	25'	-
6XBSE30034HADS	-	30	3	60	230	1750	M	25'	-
6XBSE30044HADS	-	30	3	60	460	1750	M	25'	-
6XBSE40034HADS	-	40	3	60	230	1750	M	25'	-
6XBSE40044HADS	-	40	3	60	460	1750	M	25'	-
6XBSE50034HADS	-	50	3	60	230	1750	M	25'	-
6XBSE50044HADS	-	50	3	60	460	1750	M	25'	-
6XBSE60034HADS	-	60	3	60	230	1750	M	25'	-
6XBSE60044HADS	-	60	3	60	460	1750	M	25'	-
6XBSE75034HADS	-	75	3	60	230	1750	M	25'	-
6XBSE75044HADS	-	75	3	60	460	1750	M	25'	-

8" Sewage, Double Seal Pumps w/ Explosion Proof Motors

Model	Part no.	HP	Phase	Hz	Volts	RPM	Automatic / Manual	Cord Length	Weight (lb)
8XBSE30046HADS	62170361	30	3	60	460	1150	M	25'	1700
8XBSE40046HADS	62170362	40	3	60	460	1150	M	25'	1700
8XBSE50046HADS	62170363	50	3	60	460	1150	M	25'	1706
8XBSE60046HADS	62170364	60	3	60	460	1150	M	25'	1711
8XBSE75046HADS	62170365	75	3	60	460	1150	M	25'	2028
8XBSE100044HADS	62170366	100	3	60	460	1750	M	25'	2050
8XBSE125044HADS	62170367	125	3	60	460	1750	M	25'	2061
8XBSE150044HADS	62170368	150	3	60	460	1750	M	25'	2258

- Weight includes packaging.
- * Consult factory for pricing.



Model	Part no.	HP	Phase	Volts	Amps	Rated RPM	Weight (lb)
2KLEIN-051	70090121	0.5	1	115	6.6	3450	37
2KLEIN-101	70090123	1	1	115	12	3450	44
2KLEIN-102	70090124	1	1	230	6	3450	43
2KLEIN-202	70090125	2	1	230	13	3450	55
2KLEIN-203	70090127	2	3	230	8	3450	55
2KLEIN-204	70090128	2	3	460	4	3450	55

• Weight includes packaging.

KLEIN

series

Practical and lightweight, they are designed for drainage of dirty water with particles of a maximum diameter of 0.2" (5 mm)



Model	Part no.	Discharge	HP	Phase	Hz	Volts	RPM	Max. amps	Weight (lb)
2KTM202	70090221	2"	2	1	60	230	3450	10	100
2KTM203	70090231	2"	2	3	60	230	3450	5.4	100
2KTM204	70090232	2"	2	3	60	460	3450	2.7	100
2KTM303	70090234	2"	3	3	60	230	3450	8.2	100
2KTM304	70090235	2"	3	3	60	460	3450	4.1	100
3KTM503	70090237	3"	5	3	60	230	3450	12.2	160
3KTM504	70090238	3"	5	3	60	460	3450	6.6	160
3KTM753	70090240	3"	7.5	3	60	230	3450	18.2	170
3KTM754	70090241	3"	7.5	3	60	460	3450	9.6	196
4KTM1003	70090243	4"	10	3	60	230	3450	24.8	278
4KTM1004	70090244	4"	10	3	60	460	3450	12.4	269
4KTM1503	70090246	4"	15	3	60	230	3450	36.4	353
4KTM1504	70090247	4"	15	3	60	460	3450	18.2	347
4KTM2004	70090249	4"	20	3	60	460	3450	24.9	373

• Weight includes packaging.

KTM series

Specially used in construction sites, portable utility, flood control, open mining, quarries, etc.



Model	Part no.	Discharge	HP	Phase	Hz	Volts	RPM	Max. amps	Weight (lb)
2KAG202	70090260	2	2	1	60	230	3450	10	95
2KAG203	70090261	2	2	3	60	230	3450	5.4	100
2KAG204	70090262	2	2	3	60	460	3450	2.7	100
2KAG303	70090263	2	3	3	60	230	3450	8.2	88
2KAG304	70090264	2	3	3	60	460	3450	4.1	105
3KAG503	70090266	3	5	3	60	230	3450	13.2	185
3KAG504	70090267	3	5	3	60	460	3450	6.9	185
4KAG503	70090268	4	5	3	60	230	3450	13.2	143
4KAG504	70090269	4	5	3	60	460	3450	6.9	170

• Weight includes packaging.

KAG

series
with a high
chrome agitator

Specially used in construction sites,
light slurry, sewage / waste water
applications, etc.



Model	Part no.	Discharge	HP	Phase	Hz	Volts	RPM	Max. amps	Weight (lb)
3KMUD553	70090271	3"	5.5	3	60	230	1750	17.5	278
3KMUD554	70090272	3"	5.5	3	60	460	1750	8.8	273
4KMUD803	70090274	4"	8	3	60	230	1750	23.5	369
4KMUD804	70090275	4"	8	3	60	460	1750	11.8	365
6KMUD1203	70090277	6"	12	3	60	230	1750	33.5	440
6KMUD1204	70090278	6"	12	3	60	460	1750	16.8	457
6KMUD1503	70090281	6"	15	3	60	230	1750	38	466
6KMUD1504	70090282	6"	15	3	60	460	1750	19	466
8KMUD2003	70090284	8"	20	3	60	230	1750	52	573
8KMUD2004	70090285	8"	20	3	60	460	1750	26	645
8KMUD3004	70090287	8"	30	3	60	460	1750	36	1000

• Weight includes packaging.

KMUD

series
with a high
chrome agitator

Specially used in construction sites, slurry, flood control, open mining, quarries, etc.



Close-Coupled

Model	Part no.	Size	HP	Phase	Volts	Enclosure	Material	Weight (lb)
BSP3CCE1	62030001	1.5 x 1.5	1.5	1	115/230	ODP	Cast iron	91
BSP3CCE3	62030002	1.5 x 1.5	1.5	3	230/460	ODP	Cast iron	84
BSP3CCE1-BF	62030101	1.5 x 1.5	1.5	1	115/230	ODP	Bronze fitted	91
BSP3CCE3-BF	62030102	1.5 x 1.5	1.5	3	230/460	ODP	Bronze fitted	84
BSP3CCE3-T	62030022	1.5 x 1.5	1.5	3	230/460	TEFC	Cast iron	85
BSP3CCE3-TBF	62030122	1.5 x 1.5	1.5	3	230/460	TEFC	Bronze fitted	85
BSP4CCE1	62030003	1.5 x 1.5	2	1	115/230	ODP	Cast iron	101
BSP4CCE3	62030004	1.5 x 1.5	2	3	230/460	ODP	Cast iron	92
BSP4CCE1-BF	62030103	1.5 x 1.5	2	1	115/230	ODP	Bronze fitted	101
BSP4CCE3-BF	62030104	1.5 x 1.5	2	3	230/460	ODP	Bronze fitted	92
BSP4CCE1-T	62030023	1.5 x 1.5	2	1	115/230	TEFC	Cast iron	112
BSP4CCE3-T	62030024	1.5 x 1.5	2	3	230/460	TEFC	Cast iron	98
BSP4CCE1-TBF	-	1.5 x 1.5	2	1	115/230	TEFC	Bronze fitted	112
BSP4CCE3-TBF	62030124	1.5 x 1.5	2	3	230/460	TEFC	Bronze fitted	98
BSP5CCE1	62030005	1.5 x 1.5	3	1	115/230	ODP	Cast iron	105
BSP5CCE3	62030006	1.5 x 1.5	3	3	230/460	ODP	Cast iron	94
BSP5CCE1-BF	62030105	1.5 x 1.5	3	1	115/230	ODP	Bronze fitted	105
BSP5CCE3-BF	62030106	1.5 x 1.5	3	3	230/460	ODP	Bronze fitted	94
BSP5CCE1-T	62030025	1.5 x 1.5	3	1	115/230	TEFC	Cast iron	117
BSP5CCE3-T	62030026	1.5 x 1.5	3	3	230/460	TEFC	Cast iron	97
BSP5CCE1-TBF	62030123	1.5 x 1.5	3	1	115/230	TEFC	Bronze fitted	117
BSP5CCE3-TBF	62030125	1.5 x 1.5	3	3	230/460	TEFC	Bronze fitted	97
BSP10CCE3	62030008	2 x 2	5	3	230/460	ODP	Cast iron	168
BSP10CCE3-BF	62030109	2 x 2	5	3	230/460	ODP	Bronze fitted	168
BSP10CCE3-T	62030027	2 x 2	5	3	230/460	TEFC	Cast iron	165
BSP10CCE3-TBF	62030129	2 x 2	5	3	230/460	TEFC	Bronze fitted	168
BSP15CCE3	62030009	3 x 3	7.5	3	230/460	ODP	Cast iron	248
BSP15CCE3-BF	62030110	3 x 3	7.5	3	230/460	ODP	Bronze fitted	248
BSP15CCE3-T	62030029	3 x 3	7.5	3	230/460	TEFC	Cast iron	251
BSP15CCE3-TBF	62030130	3 x 3	7.5	3	230/460	TEFC	Bronze fitted	251
BSP20CCE3	62030010	3 x 3	10	3	230/460	ODP	Cast iron	294
BSP20CCE3-BF	62030112	3 x 3	10	3	230/460	ODP	Bronze fitted	294
BSP20CCE3-T	62030030	3 x 3	10	3	230/460	TEFC	Cast iron	301
BSP20CCE3-TBF	62030131	3 x 3	10	3	230/460	TEFC	Bronze fitted	301
BSP25CCE3	62030011	3 x 3	15	3	230/460	ODP	Cast iron	322
BSP25CCE3-BF	62030111	3 x 3	15	3	230/460	ODP	Bronze fitted	322
BSP25CCE3-T	62030031	3 x 3	15	3	230/460	TEFC	Cast iron	341
BSP25CCE3-TBF	62030132	3 x 3	15	3	230/460	TEFC	Bronze fitted	341



Frame mounted

Model	Part no.	Size	Description	Weight (lb)
BSP5CU	62040101	1.5"	Suction & discharge bearing frame mounted	78
BSP7CU	62040102	2"	Suction & discharge bearing frame mounted	82
BSP10ICU	62040103	2"	Suction & discharge bearing frame mounted	88
BSP15ICU	62040104	3"	Suction & discharge bearing frame mounted	224
BSP20ICU	62040105	3"	Suction & discharge bearing frame mounted	224
BSP25ICU	62040106	3"	Suction & discharge bearing frame mounted	236
BSP40MU	62040007	4"	Self-priming pump 40MU	330
BSP200MU	62040010	10"	Self-priming pump 200MU	1298

• Weight includes packaging.



Frame mounted

Model	Part no.	Size	Description	Weight (lb)
SH3-U	62040201	3"	Solids handling self-priming pump	545
SH4-U	62040202	4"	Solids handling self-priming pump	735
SH6-U	62040203	6"	Solids handling self-priming pump	980
SH8-U	62040204	8"	Solids handling self-priming pump	1575
SH3-RA	31076601	3"	Rotating Assembly SH3	140
SH4-RA	31076602	4"	Rotating Assembly SH4	150
SH6-RA	31076603	6"	Rotating Assembly SH6	301
SH8-RA	31076604	8"	Rotating Assembly SH8	320

• Weight includes packaging.

Engine driven

Model	Size	HP	SPH SLD HNDLG	Engine
SH4-4TNV88C	4" x 4"	45.6	3"	Yanmar (diesel)
SH6-4TNV98C	6" x 6"	67.6	3"	Yanmar (diesel)

- Trailer is not D.O.T. approved.
- Engine is EPA approved.
- Diesel engine is Final Tier 4.

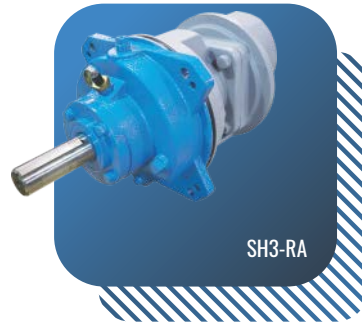

Close-Coupled - Provided with Premium Efficiency motors

Model	Part no.	Size	HP	Phase	RPM	Enclosure
IA1-3-2-1	62212007	1½" x 1" x 7" T	3	1	3500	TEFC
IA1-5-2-1	62212008	1½" x 1" x 7" T	5	1	3500	TEFC
IA1-7.5-2-1	62212009	1½" x 1" x 7" T	7.5	1	3500	TEFC
IA1-2-4	62212001	1½" x 1" x 7" T	2	3	1750	TEFC
IA1-3-2	62212002	1½" x 1" x 7" T	3	3	3500	TEFC
IA1-5-2	62212003	1½" x 1" x 7" T	5	3	3500	TEFC
IA1-7.5-2	62212004	1½" x 1" x 7" T	7.5	3	3500	TEFC
IA1½-5-2-1	62212018	2" x 1½" x 9" T	5	1	3500	TEFC
IA1½-7.5-2-1	62212019	2" x 1½" x 9" T	7.5	1	3500	TEFC
IA1½-5-2	62212011	2" x 1½" x 9" T	5	3	3500	TEFC
IA1½-7.5-2	62212012	2" x 1½" x 9" T	7.5	3	3500	TEFC
IA1½-10-2	62212013	2" x 1½" x 9" T	10	3	3500	TEFC
IA1½-15-2	62212014	2" x 1½" x 9" T	15	3	3500	TEFC
IA1½-20-2	62212015	2" x 1½" x 9" T	20	3	3500	TEFC
IA1½H-3-4	62212021	2" x 1½" x 9" T	3	3	1750	TEFC
IA1½H-15-2	62212025	2" x 1½" x 9" T	15	3	3500	TEFC
IA1½H-20-2	62212026	2" x 1½" x 9" T	20	3	3500	TEFC
IA1½H-25-2	62212027	2" x 1½" x 9" T	25	3	3500	TEFC
IA1½H-30-2	62212028	2" x 1½" x 9" T	30	3	3500	TEFC
IA1½XH-3-4	62212031	2" x 1½" x 10" T	3	3	1750	TEFC
IA1½XH-5-4	62212033	2" x 1½" x 10" T	5	3	1750	TEFC
IA1½XH-15-2	62212036	2" x 1½" x 10" T	15	3	3500	TEFC
IA1½XH-20-2	62212037	2" x 1½" x 10" T	20	3	3500	TEFC
IA1½XH-25-2	62212038	2" x 1½" x 10" T	25	3	3500	TEFC
IA1½XH-30-2	62212039	2" x 1½" x 10" T	30	3	3500	TEFC
IA2-2-4	62212041	2½" x 2" x 9" T	2	3	1750	TEFC
IA2-10-2	62212045	2½" x 2" x 9" T	10	3	3500	TEFC
IA2-15-2	62212046	2½" x 2" x 9" T	15	3	3500	TEFC
IA2-20-2	62212047	2½" x 2" x 9" T	20	3	3500	TEFC
IA2-25-2	62212048	2½" x 2" x 9" T	25	3	3500	TEFC
IA2-30-2	62212049	2½" x 2" x 9" T	30	3	3500	TEFC

- T = NPT Thread
- Impeller material is cast iron.



Close-Coupled - Provided with Premium Efficiency motors

Model	Part no.	Size	HP	Phase	RPM	Enclosure
IA2H-25-2	62212056	2½" x 2" x 9" T	25	3	3500	TEFC
IA2H-30-2	62212057	2½" x 2" x 9" T	30	3	3500	TEFC
IA2EH-5-4	62212063	3" x 2" x 9" T	5	3	1750	TEFC
IA2EH-30-2	62212067	3" x 2" x 9" T	30	3	3500	TEFC
IA2EH-40-2	62212068	3" x 2" x 9" T	40	3	3500	TEFC
IA2EH-50-2	62212069	3" x 2" x 9" T	50	3	3500	TEFC
IA2EXH-7.5-4	62212076	3" x 2" x 10" T	7.5	3	1750	TEFC
IA2EXH-10-4	62212077	3" x 2" x 10" T	10	3	1750	TEFC
IA2EXH-50-2	62212078	3" x 2" x 10" T	50	3	3500	TEFC
IA2EXH-60-2	62212079	3" x 2" x 10" T	60	3	3500	TEFC
IA2HH-30-2	62212086	3" x 2" x 10" T	30	3	3500	TEFC
IA2HH-40-2	62212087	3" x 2" x 10" T	40	3	3500	TEFC
IA2½-3-4	62212091	3" x 2½" x 9" T	3	3	1750	TEFC
IA2½-5-4	62212093	3" x 2½" x 9" T	5	3	1750	TEFC
IA2½-10-2	62212094	3" x 2½" x 9" T	10	3	3500	TEFC
IA2½-15-2	62212095	3" x 2½" x 9" T	15	3	3500	TEFC
IA2½-20-2	62212096	3" x 2½" x 9" T	20	3	3500	TEFC
IA2½-25-2	62212097	3" x 2½" x 9" T	25	3	3500	TEFC
IA2½-30-2	62212098	3" x 2½" x 9" T	30	3	3500	TEFC
IA2½-40-2	62212099	3" x 2½" x 9" T	40	3	3500	TEFC
IA2½H-40-2	62212105	4" x 2½" x 9" T	40	3	3500	TEFC
IA2½H-50-2	62212106	4" x 2½" x 9" T	50	3	3500	TEFC
IA2½H-60-2	62212107	4" x 2½" x 9" T	60	3	3500	TEFC
IA2½H-75-2	62212108	4" x 2½" x 9" T	75	3	3500	TEFC
IA2½H-100-2	62212109	4" x 2½" x 9" T	100	3	3500	TEFC
IA2½BJM-15-4	62212116	4" x 2½" x 13" T	15	3	1750	TEFC
IA2½BJM-20-4	62212117	4" x 2½" x 13" T	20	3	1750	TEFC
IA2½BJM-25-4	62212118	4" x 2½" x 13" T	25	3	1750	TEFC
IA2½BJM-30-4	62212119	4" x 2½" x 13" T	30	3	1750	TEFC
IA3-3-4	62212121	4" x 3" x 9" T	3	3	1750	TEFC
IA3-5-4	62212122	4" x 3" x 9" T	5	3	1750	TEFC
IA3-7.5-4	62212123	4" x 3" x 9" T	7.5	3	1750	TEFC
IA3-15-2	62212126	4" x 3" x 9" T	15	3	3500	TEFC
IA3-20-2	62212127	4" x 3" x 9" T	20	3	3500	TEFC
IA3-25-2	62212128	4" x 3" x 9" T	25	3	3500	TEFC
IA3-30-2	62212129	4" x 3" x 9" T	30	3	3500	TEFC
IA3-40-2	62212130	4" x 3" x 9" T	40	3	3500	TEFC
IA3-50-2	62212131	4" x 3" x 9" T	50	3	3500	TEFC
IA3H-30-2	62212135	4" x 3" x 9" T	30	3	3500	TEFC
IA3H-40-2	62212136	4" x 3" x 9" T	40	3	3500	TEFC
IA3H-50-2	62212137	4" x 3" x 9" T	50	3	3500	TEFC
IA3H-60-2	62212138	4" x 3" x 9" T	60	3	3600	TEFC
IA3H-75-2	62212139	4" x 3" x 9" T	75	3	3500	TEFC

- T = NPT Thread

- Impeller material is cast iron.

Close-Coupled - Provided with Premium Efficiency motors

Model	Part no.	Size	HP	Phase	RPM	Enclosure
IA3BJM-15-4	62212145	4" x 3" x 13½" F	15	3	1750	TEFC
IA3BJM-20-4	62212146	4" x 3" x 13½" F	20	3	1750	TEFC
IA3BJM-25-4	62212147	4" x 3" x 13½" F	25	3	1750	TEFC
IA3BJM-30-4	62212148	4" x 3" x 13½" F	30	3	1750	TEFC
IA3BJM-40-4	62212149	4" x 3" x 13½" F	40	3	1750	TEFC
IA4-10-4	62212153	6" x 4" x 10" F	10	3	1750	TEFC
IA4-15-4	62212154	6" x 4" x 10" F	15	3	1750	TEFC
IA4-20-4	62212155	6" x 4" x 10" F	20	3	1750	TEFC
IA4-40-2	62212161	6" x 4" x 10" F	40	3	3500	TEFC
IA4-50-2	62212162	6" x 4" x 10" F	50	3	3500	TEFC
IA4-60-2	62212163	6" x 4" x 10" F	60	3	3500	TEFC
IA4-75-2	62212164	6" x 4" x 10" F	75	3	3500	TEFC
IA4-100-2	62212165	6" x 4" x 10" F	100	3	3500	TEFC
IA4-125-2	62212166	6" x 4" x 10" F	125	3	3500	TEFC
IA4BJH-20-4	62212173	6" x 4" x 13" F	20	3	1750	TEFC
IA4BJH-25-4	62212174	6" x 4" x 13" F	25	3	1750	TEFC
IA4BJH-30-4	62212175	6" x 4" x 13" F	30	3	1750	TEFC
IA4BJH-40-4	62212176	6" x 4" x 13" F	40	3	1750	TEFC
IA4BJH-50-4	62212177	6" x 4" x 13" F	50	3	1750	TEFC
IA4BJH-60-4	62212178	6" x 4" x 13" F	60	3	1750	TEFC
IA4BJH-75-4	62212179	6" x 4" x 13" F	75	3	1750	TEFC
IA6BJM-30-4	62212183	8" x 6" x 13" F	30	3	1750	TEFC
IA6BJM-40-4	62212184	8" x 6" x 13" F	40	3	1750	TEFC
IA6BJM-50-4	62212185	8" x 6" x 13" F	50	3	1750	TEFC
IA6BJM-60-4	62212186	8" x 6" x 13" F	60	3	1750	TEFC
IA6BJM-75-4	62212187	8" x 6" x 13" F	75	3	1750	TEFC

- F = Flange
- Impeller material is cast iron.

Suction & discharge flange kits for IA / IB series

Part no.	Description
30400440D	Flange kit 1½" x 2"
30400440E	Flange kit 2" x 2½"
30400438D	Flange kit 2" x 3"
30400440B	Flange kit 2½" x 3"
30400428G	Flange kit 2½" x 4"
30400440	Flange kit 3" x 4"

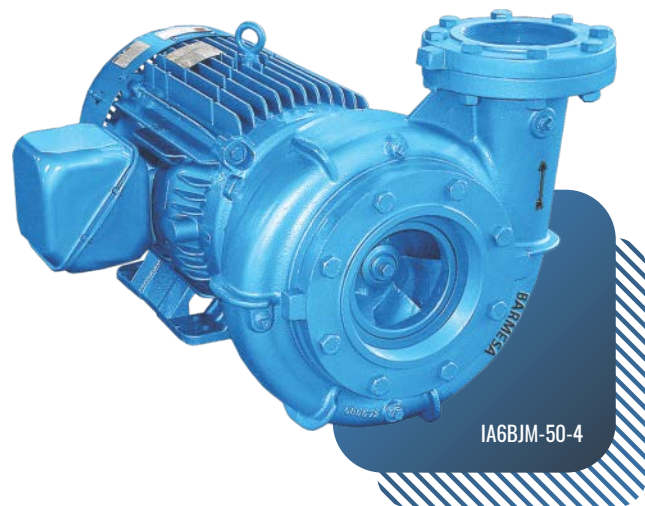

Close-Coupled - Provided with Premium Efficiency motors

Model	Part no.	Size	HP	Phase	RPM	Enclosure	Impeller
IB1½-3-2-1	62071061	2" x 1½" T	3	1	3500	TEFC	Stainless steel
IB1½-5-2-1	62071062	2" x 1½" T	5	1	3500	TEFC	Stainless steel
IB1½-7.5-2-1	62071063	2" x 1½" T	7.5	1	3500	TEFC	Stainless steel
IB1½-1-4	62071001	2" x 1½" T	1	3	1750	TEFC	Stainless steel
IB1½-1.5-2	62071002	2" x 1½" T	1.5	3	3500	TEFC	Stainless steel
IB1½-1.5-4	62071003	2" x 1½" T	1.5	3	1750	TEFC	Stainless steel
IB1½-2-2	62071004	2" x 1½" T	2	3	3500	TEFC	Stainless steel
IB1½-2-4	62071005	2" x 1½" T	2	3	1750	TEFC	Stainless steel
IB1½-3-2	62071006	2" x 1½" T	3	3	3500	TEFC	Stainless steel
IB1½-5-2	62071007	2" x 1½" T	5	3	3500	TEFC	Stainless steel
IB1½-7.5-2	62071008	2" x 1½" T	7.5	3	3500	TEFC	Stainless steel
IB2-3-2-1	62071071	2½" x 2" T	3	1	3500	TEFC	Stainless steel
IB2-5-2-1	62071072	2½" x 2" T	5	1	3500	TEFC	Stainless steel
IB2-7.5-2-1	62071073	2½" x 2" T	7.5	1	3500	TEFC	Stainless steel
IB2-1-4	62071021	2½" x 2" T	1	3	1750	TEFC	Stainless steel
IB2-1.5-4	62071022	2½" x 2" T	1.5	3	1750	TEFC	Stainless steel
IB2-2-2	62071023	2½" x 2" T	2	3	3500	TEFC	Stainless steel
IB2-2-4	62071024	2½" x 2" T	2	3	1750	TEFC	Stainless steel
IB2-3-2	62071025	2½" x 2" T	3	3	3500	TEFC	Stainless steel
IB2-5-2	62071026	2½" x 2" T	5	3	3500	TEFC	Stainless steel
IB2-7.5-2	62071027	2½" x 2" T	7.5	3	3500	TEFC	Stainless steel
IB2-10-2	62071028	2½" x 2" T	10	3	3500	TEFC	Stainless steel
IB2½-5-2-1	62070081	3" x 2½" T	5	1	3500	TEFC	Stainless steel
IB2½-7.5-2-1	62071082	3" x 2½" T	7.5	1	3500	TEFC	Stainless steel
IB2½-1-4	62071041	3" x 2½" T	1	3	1750	TEFC	Stainless steel
IB2½-1.5-4	62071042	3" x 2½" T	1.5	3	1750	TEFC	Stainless steel
IB2½-2-4	62071043	3" x 2½" T	2	3	1750	TEFC	Stainless steel
IB2½-3-4	62071044	3" x 2½" T	3	3	1750	TEFC	Stainless steel
IB2½-5-2	62071045	3" x 2½" T	5	3	3500	TEFC	Stainless steel
IB2½-7.5-2	62071046	3" x 2½" T	7.5	3	3500	TEFC	Stainless steel
IB2½-10-2	62071047	3" x 2½" T	10	3	3500	TEFC	Stainless steel
IB2½-15-2	62071048	3" x 2½" T	15	3	3500	TEFC	Stainless steel

• T = NPT Thread



IB2-5-2



IB2½-5-2

Close-Coupled - Provided with Premium Efficiency motors

Model	Part no.	Size	HP	Phase	RPM	Enclosure	Impeller
IC1¼-1-2-1	62071502	1½" x 1¼" T	1	1	3500	TEFC	Cast iron
IC1¼-1.5-2-1	62071504	1½" x 1¼" T	1.5	1	3500	TEFC	Cast iron
IC1¼-2-2-1	62071506	1½" x 1¼" T	2	1	3500	TEFC	Cast iron
IC1¼-3-2-1	62071508	1½" x 1¼" T	3	1	3500	TEFC	Cast iron
IC1¼-1-2	62071501	1½" x 1¼" T	1	3	3500	TEFC	Cast iron
IC1¼-1.5-2	62071503	1½" x 1¼" T	1.5	3	3500	TEFC	Cast iron
IC1¼-2-2	62071505	1½" x 1¼" T	2	3	3500	TEFC	Cast iron
IC1¼-3-2	62071507	1½" x 1¼" T	3	3	3500	TEFC	Cast iron
IC1½-1.5-2-1	62071510	1½" x 1½" T	1.5	1	3500	TEFC	Noryl
IC1½-2-2-1	62071512	1½" x 1½" T	2	1	3500	TEFC	Noryl
IC1½-3-2-1	62071514	1½" x 1½" T	3	1	3500	TEFC	Noryl
IC1½-1.5-2	62071509	1½" x 1½" T	1.5	3	3500	TEFC	Noryl
IC1½-2-2	62071511	1½" x 1½" T	2	3	3500	TEFC	Noryl
IC1½-3-2	62071513	1½" x 1½" T	3	3	3500	TEFC	Noryl
IC1½H-5-2	62071515	1½" x 1½" T	5	3	3500	TEFC	Cast iron
IC1½H-7.5-2	62071516	1½" x 1½" T	7.5	3	3500	TEFC	Cast iron
IC1½H-10-2	62071517	1½" x 1½" T	10	3	3500	TEFC	Cast iron

• T = NPT Thread

Bearing frame mounted

Model	Part no.	Size	Description	Weight (lb)
BES4030HCU	70010152	4" x 3"	End-suction centrifugal bearing frame mounted	254
BES2025CU7	70010153	2" x 2½"	End-suction centrifugal bearing frame mounted	150
BES2025CU9	70010154	2" x 2½"	End-suction centrifugal bearing frame mounted	167
BES3040CU9	70010155	3" x 4"	End-suction centrifugal bearing frame mounted	254
BES4050CU9	70010156	4" x 5"	End-suction centrifugal bearing frame mounted	270

- Weight includes packaging.
- Consult factory for availability.

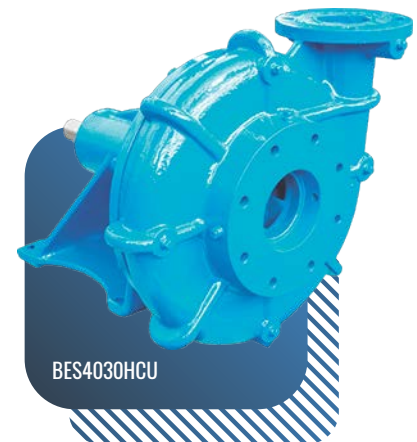

Close Coupled Stainless Steel Pumps

Model	Part no.	Size	HP	Phase	RPM	Enclosure
BCS1-1-2	62181011	1¼" x 1" - 5	1	3	3450	ODP
BCS1-1.5-2	-	1¼" x 1" - 5	1.5	3	3450	ODP
BCS1-2-2	62181015	1¼" x 1" - 5	2	3	3450	ODP
BCS1-3-2	62181017	1¼" x 1" - 5	3	3	3450	ODP
BCS1¼-1-2	62181021	1½" x 1¼" - 5	1	3	3450	ODP
BCS1¼-1.5-2	62181023	1½" x 1¼" - 5	1.5	3	3450	ODP
BCS1¼-2-2	62181025	1½" x 1¼" - 5	2	3	3450	ODP
BCS1¼-3-2	62181027	1½" x 1¼" - 5	3	3	3450	ODP
BCSF1½-6-1-4	-	2" x 1½" - 6	1	3	1750	TEFC
BCSF1½-3-2	62181143	2" x 1½" - 6	3	3	3450	TEFC
BCSF1½-6-5-2	62181145	2" x 1½" - 6	5	3	3450	TEFC
BCSF1½-8-1-4	-	2" x 1½" - 8	1	3	1750	TEFC
BCSF1½-2-4	62181153	2" x 1½" - 8	2	3	1750	TEFC
BCSF1½-3-4	62181155	2" x 1½" - 8	3	3	1750	TEFC
BCSF1½-8-5-2	62181161	2" x 1½" - 8	5	3	3450	TEFC
BCSF1½-7.5-2	62181163	2" x 1½" - 8	7.5	3	3450	TEFC
BCSF1½-10-2	62181165	2" x 1½" - 8	10	3	3450	TEFC
BCSF1½-15-2	62181167	2" x 1½" - 8	15	3	3450	TEFC
BCSF1½-20-2	62181169	2" x 1½" - 8	20	3	3450	TEFC
BCSF2-2-4	-	3" x 2" - 7	2	3	1750	TEFC
BCSF2-3-4	62181173	3" x 2" - 7	3	3	1750	TEFC
BCSF2-3-2	-	3" x 2" - 7	3	3	3450	TEFC
BCSF2-5-2	62181181	3" x 2" - 7	5	3	3450	TEFC
BCSF2-7.5-2	62181183	3" x 2" - 7	7.5	3	3450	TEFC
BCSF2-10-2	62181185	3" x 2" - 7	10	3	3450	TEFC
BCSF2-15-2	62181187	3" x 2" - 7	15	3	3450	TEFC
BCSF2-20-2	62181189	3" x 2" - 7	20	3	3450	TEFC



BCS1-1.5-2

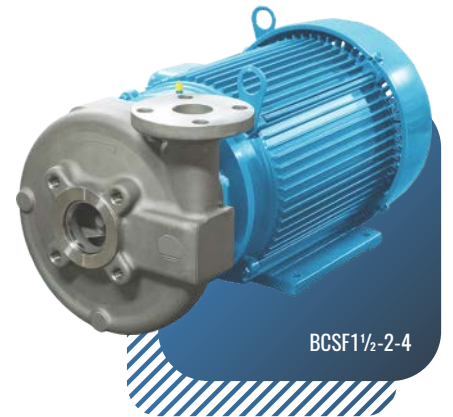

BCSF1½-2-4

Pump kits without motor

Model	Part no.	Size	Frame Size	Connection
BCS1 x 1¼-5	31076701	1" x 1¼"	56j	NPT
BCS1¼ x 1½-5	31076703	1¼" x 1½"	56j	NPT
BCSF1½ x 2-6	31076705	1½" x 2"	145-184 JM	Flange
BCSF1½ x 2-8	31076707	1½" x 2"	145-184 JM	Flange
BCSF1½ x 2-8	31076709	1½" x 2"	213-215 JM*	Flange
BCSF2 x 3-7	31076711	2" x 3"	145-184 JM	Flange
BCSF2 x 3-7	31076713	2" x 3"	213-215 JM*	Flange

- Kit delivered at maximum impeller diameter.
- Kit includes mechanical seal, hardware, gaskets, etc.
- Verify the frame size for the motor, refer to the technical data provided in our catalog.
- Mechanical seals for BCS are Type 1, size: 5/8", Carbon / Silicon Carbide / Viton.
- Mechanical seals for BCSF are Type 1, size: 1¼", Carbon / Silicon Carbide / Viton.
- * 254 and 256 frame with 215 JM shaft extension, to be provided by motor supplier.



PUMP KITS

Close Coupled - Provided with TEFC High Efficiency motors

Model	Part no.	Size	HP	Phase	Volts	RPM	Weight (lb)
CD70-1-2	70080051	1¼" x 1"	1	3	230/460	3450	30.8
CD70-1.5-2	70080052	1¼" x 1"	1.5	3	230/460	3450	30.8
CD70-1.5-2 VS	70080052B	1¼" x 1"	1.5	3	230/460	3450	30.8
CD70-2-2	70080053	1¼" x 1"	2	3	230/460	3450	44
CD70-2-2 VS	70080053B	1¼" x 1"	2	3	230/460	3450	44
CD120-1.5-2	70080061	1½" x 1¼"	1.5	3	230/460	3450	44
CD120-1.5-2 VS	70080091	1½" x 1¼"	1.5	3	230/460	3450	44
CD120-2-2	70080062	1½" x 1¼"	2	3	230/460	3450	48
CD120-2-2 VS	70080062C	1½" x 1¼"	2	3	230/460	3450	48
CD120-3-2	70080063	1½" x 1¼"	3	3	230/460	3450	50.7
CD120-3-2 VS	70080063B	1½" x 1¼"	3	3	230/460	3450	50.7
CD200-2-2	70080071	1½" x 1¼"	2	3	230/460	3450	44
CD200-2-2 VS	70080071B	1½" x 1¼"	2	3	230/460	3450	44
CD200-3-2	70080072	1½" x 1¼"	3	3	230/460	3450	50.7
CD200-3-2 VS	70080072B	1½" x 1¼"	3	3	230/460	3450	50.7

• VS =Viton seal.

• Up to 158 °F. Consult factory for higher temperatures and up to 221 °F.

• Delivery time 10 weeks.

Close Coupled - Provided with TEFC High Efficiency motors

Model	Part no.	Size	HP	Phase	Volts	RPM
PS1¼-1-4	62390101	2" x 1¼"	1	3	230/460	1750
PS1¼-1.5-4	62390102	2" x 1¼"	1.5	3	230/460	1750
PS1¼-3-2	62390103	2" x 1¼"	3	3	230/460	3500
PS1¼-5-2	62390104	2" x 1¼"	5	3	230/460	3500
PS1¼-7.5-2	62390105	2" x 1¼"	7.5	3	230/460	3500
PS1¼-10-2	62390106	2" x 1¼"	10	3	230/460	3500
PS1½-5-2	62390122	2½" x 1½"	5	3	230/460	3500
PS1½-7.5-2	62390123	2½" x 1½"	7	3	230/460	3500
PS1½-10-2	62390124	2½" x 1½"	10	3	230/460	3500
PS1½-15-2	62390125	2½" x 1½"	15	3	230/460	3500
PS2-2-4	62390141	2½" x 2"	2	3	230/460	1750
PS2-7.5-2	62390142	2½" x 2"	7.5	3	230/460	3500
PS2-10-2	62390143	2½" x 2"	10	3	230/460	3500
PS2-15-2	62390144	2½" x 2"	15	3	230/460	3500



Close Coupled - Provided with TEFC High Efficiency motors

Model	Part no.	Size	HP	Phase	Volts	RPM
SOX1¼-1.5-2	70080101	2" x 1¼"	1.5	3	230/460	3450
SOX1¼-2-2	70080102	2" x 1¼"	2	3	230/460	3450
SOX1¼-3-2	70080103	2" x 1¼"	3	3	230/460	3450
SOX1¼-4-2	70080104	2" x 1¼"	4	3	230/460	3450
SOX1¼-5.5-2	70080105	2" x 1¼"	5.5	3	230/460	3450
SOX1¼-7.5-2	70080106	2" x 1¼"	7.5	3	230/460	3450
SOX1½-5.5-2	70080114	2" x 1½"	5.5	3	230/460	3450
SOX1½-7.5-2	70080115	2" x 1½"	7.5	3	230/460	3450
SOX1½-10-2	70080116	2" x 1½"	10	3	230/460	3450
SOX1½-15-2	70080117	2" x 1½"	15	3	230/460	3450
SOX2-5.5-2	70080122	2½" x 2"	5.5	3	230/460	3450
SOX2-7.5-2	70080123	2½" x 2"	7.5	3	230/460	3450
SOX2-10-2	70080124	2½" x 2"	10	3	230/460	3450
SOX2-12.5-2	-	2½" x 2"	12.5	3	230/460	3450
SOX2-15-2	70080125	2½" x 2"	15	3	230/460	3450
SOX2-20-2	70080126	2½" x 2"	20	3	230/460	3450
SOX2-25-2	70080127	2½" x 2"	25	3	230/460	3450
SOX2½-7.5-2	70080132	3" x 2½"	7.5	3	230/460	3450
SOX2½-10-2	70080133	3" x 2½"	10	3	230/460	3450
SOX2½-12.5-2	70080134	3" x 2½"	12.5	3	230/460	3450
SOX2½-15-2	70080135	3" x 2½"	15	3	230/460	3450
SOX2½-20-2	70080136	3" x 2½"	20	3	230/460	3450
SOX2½-25-2	70080137	3" x 2½"	25	3	230/460	3450
SOX2½-30-2	70080138	3" x 2½"	30	3	230/460	3450
SOX2½-40-2	70080139	3" x 2½"	40	3	230/460	3450
SOX3-15-2	70080141	4" x 3"	15	3	230/460	3450
SOX3-20-2	70080142	4" x 3"	20	3	230/460	3450
SOX3-25-2	70080143	4" x 3"	25	3	230/460	3450
SOX3-30-2	70080144	4" x 3"	30	3	230/460	3450
SOX3-40-2	70080145	4" x 3"	40	3	230/460	3450
SOX3-50-2	70080146	4" x 3"	50	3	230/460	3450



Flange kits for SOX pumps

Part no.	Description
70080151	Flange kit SOX - 2" x 1¼"
70080153	Flange kit SOX - 2½" x 1½"
70080155	Flange kit SOX - 2½" x 2"
70080157	Flange kit SOX - 3" x 2½"
70080159	Flange kit SOX - 4" x 3"

Model	Part no.	HP	Phase	Pole	Frame
1.5 x 1.5 x 6	60400002	1	3	4	143TC
	60400004	2	3	2	145TC
	60400007	3	3	2	182TC
	60400010	5	3	2	184TC
2 x 2 x 6	60400052	1	3	4	143TC
	60400053	1	3	6	145TC
	60400055	1.5	3	4	145TC
	60400058	2	3	4	145TC
	60400060	3	3	2	182TC
	60400063	5	3	2	184TC
	60400066	7.5	3	2	213TC
	60400069	10	3	2	215TC
3 x 3 x 6	60400072	15	3	2	254TC
	60400172	1	3	4	143TC
	60400173	1	3	6	145TC
	60400175	1.5	3	4	145TC
	60400178	2	3	4	145TC
	60400181	3	3	4	182TC
	60400183	5	3	2	184TC
	60400186	7.5	3	2	213TC
	60400189	10	3	2	215TC
	60400192	15	3	2	254TC
4 x 4 x 6	60400195	20	3	2	256TC
	60400402	1	3	4	143TC
	60400403	1	3	6	145TC
	60400405	1.5	3	4	145TC
	60400408	2	3	4	145TC
	60400411	3	3	4	182TC
	60400416	7.5	3	2	213TC
	60400419	10	3	2	215TC
	60400422	15	3	2	254TC
	60400425	20	3	2	256TC
6 x 6 x 6	60400763	1	3	6	145TC
	60400766	1.5	3	6	182TC
	60400769	2	3	6	184TC
	60400771	3	3	4	182TC
	60400774	5	3	4	184TC
	60400777	7.5	3	4	213TC
	60400022	1	3	4	143TC
1.5 x 1.5 x 8	60400023	1	3	6	145TC
	60400025	1.5	3	4	145TC
	60400028	2	3	4	145TC
	60400030	3	3	2	182TC
	60400033	5	3	2	184TC
	60400036	7.5	3	2	213TC
	60400039	10	3	2	215TC
	60400042	15	3	2	254TC
60400082	1	3	4	143TC	
60400083	1	3	6	145TC	
60400085	1.5	3	4	145TC	
60400086	1.5	3	6	182TC	
60400088	2	3	4	145TC	
60400091	3	3	4	182TC	
60400094	5	3	4	184TC	

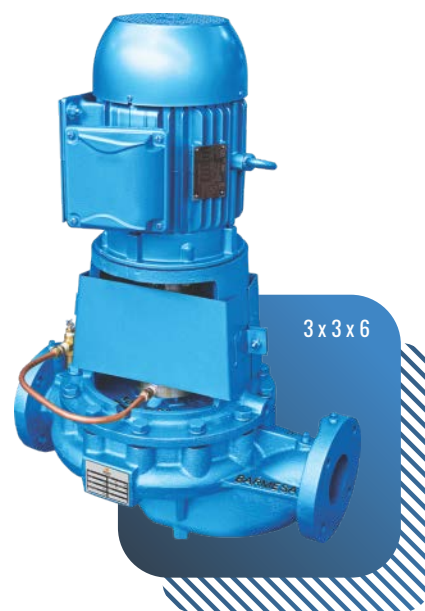

Model	Part no.	HP	Phase	Pole	Frame
2 x 2 x 8	60400096	7.5	3	2	213TC
	60400099	10	3	2	215TC
	60400102	15	3	2	254TC
	60400105	20	3	2	256TC
	60400108	25	3	2	284TSC
	60400111	30	3	2	286TSC
	60400114	40	3	2	324TSC
3 x 3 x 8	60400203	1	3	6	145TC
	60400205	1.5	3	4	145TC
	60400206	1.5	3	6	182TC
	60400208	2	3	4	145TC
	60400219	2	3	6	184TC
	60400211	3	3	4	182TC
	60400214	5	3	4	184TC
	60400217	7.5	3	4	213TC
	60400209	10	3	2	215TC
	60400212	15	3	2	254TC
	60400215	20	3	2	256TC
	60400218	25	3	2	284TSC
	60400221	30	3	2	286TSC
	60400204	40	3	2	324TSC
60400227	50	3	2	326TSC	
4 x 4 x 8	60400433	1	3	6	145TC
	60400436	1.5	3	6	182TC
	60400439	2	3	6	184TC
	60400441	3	3	4	182TC
	60400442	3	3	6	213TC
	60400444	5	3	4	184TC
	60400447	7.5	3	4	213TC
	60400450	10	3	4	215TC
	60400453	15	3	4	254TC
	5 x 5 x 8	60400663	1	3	6
60400665		1.5	3	4	145TC
60400666		1.5	3	6	182TC
60400668		2	3	4	145TC
60400669		2	3	6	184TC
60400671		3	3	4	182TC
60400674		5	3	4	184TC
60400677		7.5	3	4	213TC
60400682		15	3	2	254TC
60400685		20	3	2	256TC
60400688		25	3	2	284TSC
60400691		30	3	2	286TSC
60400694		40	3	2	324TSC
60400697		50	3	2	326TSC
60400700	60	3	2	-	
6 x 6 x 8	60400793	2	3	6	184TC
	60400796	3	3	6	213TC
	60400799	5	3	6	215TC
	60400801	7.5	3	4	213TC
	60400804	10	3	4	215TC
	60400807	15	3	4	254TC
	60400810	20	3	4	256TC
8 x 8 x 8	60401003	3	3	6	213TC
	60401006	5	3	6	215TC

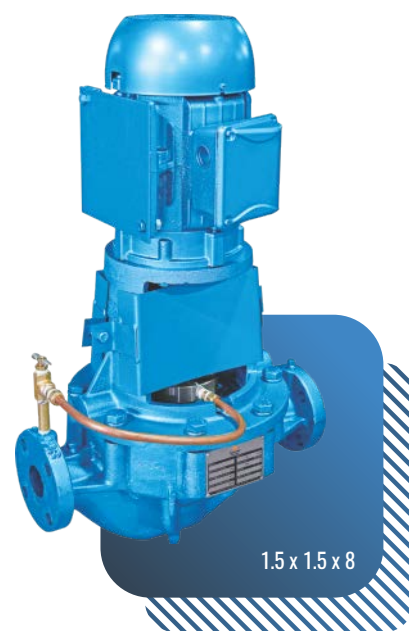

1.5 x 1.5 x 8

Model	Part no.	HP	Phase	Pole	Frame
8 x 8 x 8	60401011	10	3	4	215TC
	60401014	15	3	4	254TC
	60401017	20	3	4	256TC
2 x 2 x 10	60400126	1.5	3	6	182TC
	60400128	2	3	4	145TC
	60400129	2	3	6	184TC
	60400131	3	3	4	182TC
	60400134	5	3	4	184TC
	60400137	7.5	3	4	213TC
	60400142	15	3	2	254TC
	60400145	20	3	2	256TC
	60400148	25	3	2	284TSC
	60400151	30	3	2	286TSC
	60400154	40	3	2	324TSC
	60400157	50	3	2	326TSC
3 x 3 x 10	60400160	60	3	2	364TSC
	60400233	1	3	6	145TC
	60400236	1.5	3	6	182TC
	60400238	2	3	4	145TC
	60400239	2	3	6	184TC
	60400241	3	3	4	182TC
	60400242	3	3	6	213TC
	60400244	5	3	4	184TC
	60400247	7.5	3	4	213TC
	60400250	10	3	4	215TC
	60400252	15	3	2	254TC
	60400255	20	3	2	256TC
4 x 4 x 10	60400258	25	3	2	284TSC
	60400261	30	3	2	286TSC
	60400264	40	3	2	324TSC
	60400267	50	3	2	326TSC
	60400270	60	3	2	364TSC
	60400273	75	3	2	365TSC
	60400276	100	3	2	405TSC
	60400463	1	3	6	145TC
	60400466	1.5	3	6	182TC
	60400469	2	3	6	184TC
	60400471	3	3	4	182TC
	60400472	3	3	6	213TC
60400474	5	3	4	184TC	
6 x 6 x 10	60400475	5	3	6	215TC
	60400477	7.5	3	4	213TC
	60400480	10	3	4	215TC
	60400483	15	3	4	254TC
	60400491	30	3	2	286TSC
	60400494	40	3	2	324TSC
	60400497	50	3	2	326TSC
	60400500	60	3	2	364TSC
	60400503	75	3	2	365TSC
	60400506	100	3	2	405TSC
	60400509	125	3	2	444TSC
	60400836	1.5	3	6	182TC
60400839	2	3	6	184TC	
60400842	3	3	6	213TC	
60400844	5	3	4	184TC	

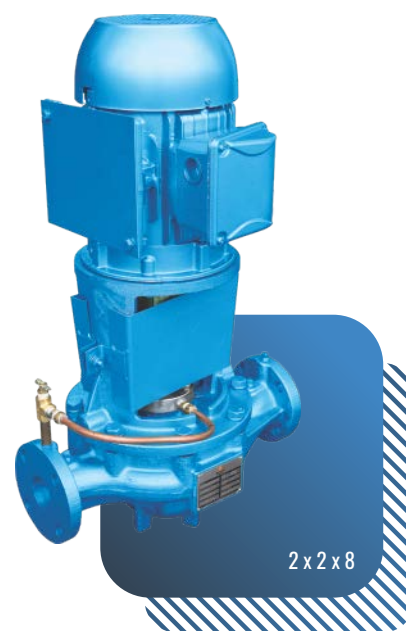

Model	Part no.	HP	Phase	Pole	Frame
6 x 6 x 10	60400845	5	3	6	215TC
	60400847	7.5	3	4	213TC
	60400848	7.5	3	6	254TC
	60400850	10	3	4	215TC
	60400853	15	3	4	254TC
	60400856	20	3	4	256TC
	60400859	25	3	4	284TC
6 x 6 x 10	60400867	50	3	2	326TSC
	60400870	60	3	2	364TSC
	60400873	75	3	2	365TSC
	60400876	100	3	2	405TSC
	60400879	125	3	2	444TSC
	60400882	150	3	2	445TSC
	60400885	200	3	2	447TSC
8 x 8 x 10	60401136	5	3	6	215TC
	60401139	7.5	3	6	254TC
	60401141	10	3	4	215TC
	60401142	10	3	6	256TC
	60401144	15	3	4	254TC
	60401145	15	3	6	284TC
	60401147	20	3	4	256TC
	60401150	25	3	4	284TC
	60401153	30	3	4	286TC
	60401156	40	3	4	324TC
4 x 4 x 11.5	60401159	50	3	4	326TC
	60400529	2	3	6	184TC
	60400532	3	3	6	213TC
	60400535	5	3	6	215TC
	60400537	7.5	3	4	213TC
	60400538	7.5	3	6	254TC
	60400540	10	3	4	215TC
	60400543	15	3	4	254TC
	60400546	20	3	4	256TC
	60400549	25	3	4	284TC
5 x 5 x 11.5	60400719	2	3	6	184TC
	60400722	3	3	6	213TC
	60400725	5	3	6	215TC
	60400727	7.5	3	4	213TC
	60400728	7.5	3	6	254TC
	60400730	10	3	4	215TC
	60400731	10	3	6	256TC
	60400733	15	3	4	254TC
6 x 6 x 11.5	60400736	20	3	4	256TC
	60400739	25	3	4	284TC
	60400742	30	3	4	286TC
	60400893	1.5	3	6	182TC
	60400896	2	3	6	184TC
	60400899	3	3	6	213TC
	60400902	5	3	6	215TC
	60400905	7.5	3	6	254TC
	60400907	10	3	4	215TC
	60400910	15	3	4	254TC
6 x 6 x 11.5	60400913	20	3	4	256TC
	60400916	25	3	4	284TC
	60400919	30	3	4	286TC



Model	Part no.	HP	Phase	Pole	Frame
6 x 6 x 11.5	60400922	40	3	4	324TC
	60401189	7.5	3	6	254TC
	60401192	10	3	6	256TC
	60401195	15	3	6	284TC
8 x 8 x 11.5	60401198	20	3	6	286TC
	60401200	25	3	4	284TC
	60401203	30	3	4	286TC
	60401206	40	3	4	324TC
	60401209	50	3	4	326TC
	60401212	60	3	4	364TC
	60401215	75	3	4	365TC
	60400283	1.5	3	6	182TC
60400286	2	3	6	184TC	
60400289	3	3	6	213TC	
60400291	5	3	4	184TC	
60400292	5	3	6	215TC	
60400294	7.5	3	4	213TC	
60400295	7.5	3	6	254TC	
60400297	10	3	4	215TC	
3 x 3 x 13	60400300	15	3	4	254TC
	60400303	20	3	4	256TC
	60400306	25	3	4	284TC
	60400314	50	3	2	326TSC
	60400317	60	3	2	364TSC
	60400320	75	3	2	365TSC
	60400323	100	3	2	405TSC
	60400326	125	3	2	444TSC
	60400329	150	3	2	445TSC
	60400575	5	3	6	215TC
60400578	7.5	3	6	254TC	
60400581	10	3	6	256TC	
60400583	15	3	4	254TC	
4 x 4 x 13	60400584	15	3	6	284TC
	60400586	20	3	4	256TC
	60400589	25	3	4	284TC
	60400592	30	3	4	286TC
	60400595	40	3	4	324TC
	60400598	50	3	4	326TC
60400955	5	3	6	215TC	
60400958	7.5	3	6	254TC	
60400961	10	3	6	256TC	
60400964	15	3	6	284TC	
6 x 6 x 13	60400966	20	3	4	256TC
	60400969	25	3	4	284TC
	60400972	30	3	4	286TC
	60400975	40	3	4	324TC
	60400978	50	3	4	326TC
	60401239	7.5	3	6	254TC
	60401242	10	3	6	256TC
	60401245	15	3	6	284TC
8 x 8 x 13	60401247	20	3	4	256TC
	60401248	20	3	6	286TC
	60401250	25	3	4	284TC
	60401251	25	3	6	324TC
	60401253	30	3	4	286TC

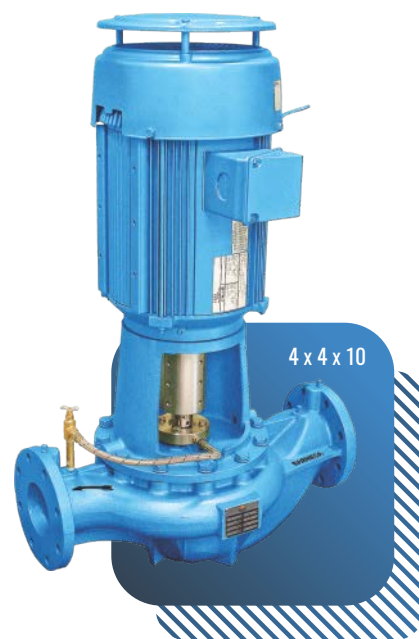

Model	Part no.	HP	Phase	Pole	Frame
8 x 8 x 13	60401250	25	3	4	284TC
	60401251	25	3	6	324TC
	60401253	30	3	4	286TC
	60401256	40	3	4	324TC
	60401259	50	3	4	326TC
	60401262	60	3	4	364TC
	60401265	75	3	4	365TC
10 x 10 x 13	60401333	10	3	6	256TC
	60401336	15	3	6	284TC
	60401339	20	3	6	286TC
	60401342	25	3	6	324TC
	60401345	30	3	6	326TC
	60401347	40	3	4	324TC
	60401348	40	3	6	364TC
	60401350	50	3	4	326TC
	60401351	50	3	6	365TC
	60401353	60	3	4	364TC
	60401356	75	3	4	365TC
12 x 12 x 13	60401359	100	3	4	405TC
	60401360	125	3	4	444TC
	60401363	150	3	4	445TC
	60401426	15	3	6	284TC
	60401429	20	3	6	286TC
	60401432	25	3	6	324TC
	60401435	30	3	6	326TC
	60401438	40	3	6	364TC
	60401440	50	3	4	326TC
	60401441	50	3	6	365TC
	60401443	60	3	4	364TC
	60401444	75	3	4	365TC
	60401446	75	3	6	405TC
60401449	100	3	4	405TC	
60401452	125	3	4	444TC	
60401455	150	3	4	445TC	
60401458	200	3	4	447TC	
60401461	250	3	4	449TC	
8 x 8 x 15	60401286	15	3	6	284TC
	60401289	20	3	6	286TC
	60401292	25	3	6	324TC
	60401295	30	3	6	326TC
	60401298	40	3	6	364TC
	60401300	50	3	4	326TC
	60401301	50	3	6	365TC
	60401303	60	3	4	364TC
	60401306	75	3	4	365TC
	60401309	100	3	4	405TC
	60401312	125	3	4	444TC
	60401315	150	3	4	445TC
	60401318	200	3	4	447TC

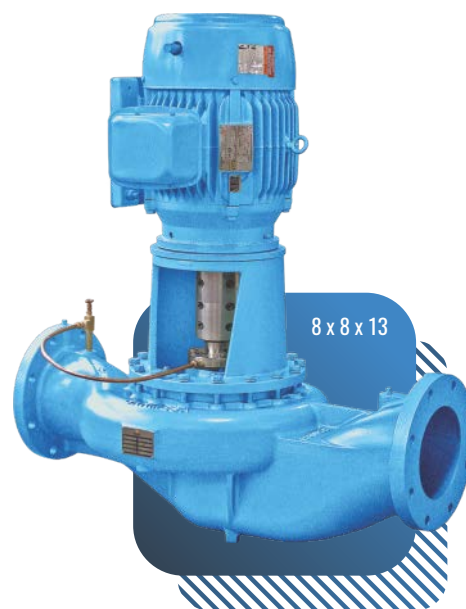

Provided with TEFC IE3 Premium Efficiency motors

Stainless steel

Model	Part no.	HP	Stages	GPM	Size
HMV5-60-103	70120101A	1	6		1¼"
HMV5-80-153	70120101B	1.5	8		1¼"
HMV5-100-203	70120101H	2	9		1¼"
HMV5-110-203	70120101C	2	11		1¼"
HMV5-130-303	70120101J	3	13		1¼"
HMV5-140-303	70120101L	3	15	5	1¼"
HMV5-160-303	70120101D	3	16		1¼"
HMV5-170-403	70120101N	4	17		1¼"
HMV5-190-403	70120101P	4	19		1¼"
HMV5-210-403	70120101R	4	21		1¼"
HMV5-230-403	70120101E	4	23		1¼"
HMV14-30-103	70120103A	1	3		1¼"
HMV14-50-153	70120103B	1.5	5		1¼"
HMV14-70-203	70120103C	2	7		1¼"
HMV14-90-303	70120103L	3	9		1¼"
HMV14-110-303	70120103D	3	11	14	1¼"
HMV14-130-403	70120103D3	4	13		1¼"
HMV14-150-403	70120103E	4	15		1¼"
HMV14-170-553	70120103P	5.5	17		1¼"
HMV14-190-553	70120103F	5.5	19		1¼"
HMV22-30-153	70120105A	1.5	3		1¼"
HMV22-40-203	70120105B	2	4		1¼"
HMV22-60-303	70120105C	3	6	22	1¼"
HMV22-90-403	70120105D	4	9		1¼"
HMV22-110-553	70120105E	5.5	11		1¼"
HMV22-150-753	70120105F	7.5	15		1¼"
HMV45-20-303	70120107A	3	2		1½"
HMV45-30-403	70120107B	4	3		1½"
HMV45-40-553	70120107C	5.5	4		1½"
HMV45-50-753	70120107H	7.5	5		1½"
HMV45-60-753	70120107D	7.5	6		1½"
HMV45-70-1003	70120107J	10	7		1½"
HMV45-80-1003	70120107E	10	8	45	1½"
HMV45-90-1503	70120107L	15	9		1½"
HMV45-100-1503	70120107N	15	10		1½"
HMV45-110-1503	70120107P	15	11		1½"
HMV45-120-1503	70120107F	15	12		1½"
HMV45-130-2003	70120107R	20	13		1½"
HMV45-140-2003	70120107T	20	14		1½"
HMV45-150-2003	70120107V	20	15		1½"
HMV45-160-2003	70120107G	20	16		1½"
HMV70-10-303	70120109A	3	1		2"
HMV70-20-553	70120109B	5.5	2		2"
HMV70-30-753	70120109C	7.5	3		2"
HMV70-40-1003	70120109D	10	4		2"
HMV70-50-1503	70120109L	15	5	70	2"
HMV70-60-1503	70120109E	15	6		2"
HMV70-70-2003	70120109N	20	7		2"
HMV70-80-2003	70120109F	20	8		2"
HMV70-90-2503	70120109P	25	9		2"
HMV70-100-2503	70120109G	25	10		2"



Drinking Water
NSF/ANSI 61
NSF/ANSI 372



Provided with TEFC IE3 Premium Efficiency motors

Stainless steel

Model	Part no.	HP	Stages	GPM	Size
HMV95-10-303	70120111A	3	1	95	2"
HMV95-20-753	70120111B	7.5	2		2"
HMV95-30-1003	70120111C	10	3		2"
HMV95-40-1503	70120111L	15	4		2"
HMV95-50-1503	70120111D	15	5		2"
HMV95-60-2003	70120111E	20	6		2"
HMV95-70-2503	70120111N	25	7		2"
HMV95-80-2503	70120111F	25	8		2"
HMV140-10-1-553	70120113A	5.5	1	140	2½"
HMV140-10-753	70120113B	7.5	1		2½"
HMV140-20-1003	70120113C	10	2		2½"
HMV140-20-2-1003	70120113N	10	2		2½"
HMV140-30-2-1503	70120113D	15	3		2½"
HMV140-30-2003	70120113P	20	3		2½"
HMV140-40-2-2003	70120113E	20	4		2½"
HMV140-40-2503	70120113R	25	4		2½"
HMV140-50-2-2503	70120113F	25	5		2½"
HMV140-50-3003	70120113T	30	5		2½"
HMV140-60-2-3003	70120113G	30	6		2½"
HMV140-60-4003	70120113V	40	6		2½"
HMV140-70-2-4003	70120113X	40	7		2½"
HMV140-70-4003	70120113H	40	7		2½"
HMV140-80-5003	70120113Z	50	8		2½"
HMV140-90-5003	70120113Z2	50	9		2½"
HMV140-90-2-5003	70120113I	50	9	2½"	
HMV140-100-2-6003	70120113Z4	60	10	2½"	
HMV140-100-6003	70120113J	60	10	2½"	
HMV200-10-1-1003	70120115A	10	1	200	3"
HMV200-10-1003	70120115B	10	1		3"
HMV200-20-2003	70120115C	20	2		3"
HMV200-30-2-2503	70120115D	25	3		3"
HMV200-30-3003	70120115E	30	3		3"
HMV200-40-4003	70120115F	40	4		3"
HMV200-50-5003	70120115G	50	5		3"
HMV200-70-2-6003	70120115H	60	7		3"
HMV200-80-2-7503	70120115I	75	8	3"	
HMV300-10-1-1503	70120117A	15	1	300	4"
HMV300-10-2003	70120117B	20	1		4"
HMV300-20-2-3003	70120117C	30	2		4"
HMV300-20-4003	70120117H	40	2		4"
HMV300-30-2-4003	70120117D	40	3		4"
HMV300-30-5003	70120117E	50	3		4"
HMV300-40-2-6003	70120117F	60	4		4"
HMV300-40-7503	70120117J	75	4		4"
HMV300-50-2-7503	70120117G	75	5	4"	



Drinking Water
NSF/ANSI 61
NSF/ANSI 372



Model	Size	ANSI	Ductile iron	Ductile iron w/ 316 SS impeller	316 SS
			Part no.	Part no.	Part no.
911S	1 x 1.5-6	AA	60340001	60340201	60340101
	1.5 x 3-6	AB	60340011	60340211	60340111
	2 x 3-6	-	60340021	60340221	60340121
	1 x 1.5-8	AA	60340002	60340202	60340102
	1.5 x 3-8	AB	60340012	60340212	60340112
911M	3 x 4-7	A70	60340031	60340231	60340131
	2 x 3-8	A60	60340022	60340222	60340122
	3 x 4-8	A70	60340032	60340232	60340132
	3 x 4-8G	A70	60340033	60340233	60340133
	1 x 2-10	A05	60340003	60340203	60340103
	1.5 x 3-10	A50	60340013	60340213	60340113
	2 x 3-10	A60	60340023	60340223	60340123
	3 x 4-10	A70	60340034	60340234	60340134
	3 x 4-10H	A40	60340035	60340235	60340135
	4 x 6-10	A80	60340041	60340241	60340141
911L	4 x 6-10H	A80	60340043	60340242	60340142
	1.5 x 3-13	A20	60340014	60340214	60340114
	2 x 3-13	A30	60340024	60340224	60340124
	3 x 4-13	A40	60340036	60340236	60340136
	4 x 6-13	A80	60340042	60340243	60340143
	1 x 2-10	A05	60340320	60340520	60340420
	1.5 x 3-10	A50	60340321	60340521	60340421
	2 x 3-10	A60	60340322	60340522	60340422
	3 x 4-10	A70	60340323	60340234B	60340423
	3 x 4-10H	A40	60340324	60340524	60340424
911LX	4 x 6-10	A80	60340325	60340525	60340425
	4 x 6-10H	A80	60340326	60340526	60340426
	1.5 x 3-13	A20	60340301	60340527	60340427
	2 x 3-13	A30	60340302	60340528	60340428
	3 x 4-13	A40	60340303	60340529	60340353
	4 x 6-13	A80	60340304	60340530	60340430
	6 x 8-13	A90	60340305	60340932	60340405
911LX	8 x 10-13	A100	60340307	60340507	60340407
	6 x 8-15	A110	60340306	60340251	60340157
	8 x 10-15	A120	60340308	60340510	60340410
	8 x 10-15G	A120	60340309	60340268	60340409

- Bare pump only, they do not include the packing gland kit.
- Pumps are delivered with impellers at full diameter.

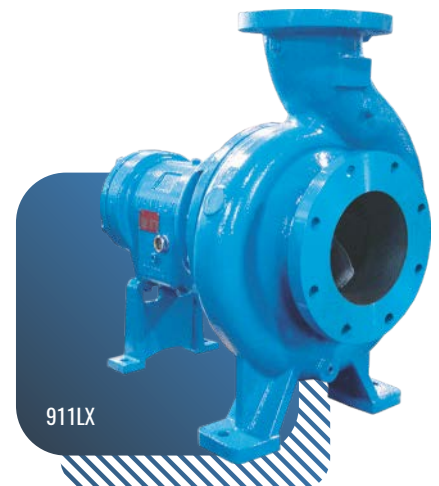

Model	Part no.	Size	Rails	Coupling	Check Valve	Weight (lb)
SRC125	62170803	1¼"	¾" or 1"	w/ upper guide bracket	No	45
SRC150	62170804	1½"	¾" or 1"	w/ upper guide bracket	No	45
SRC200	62170805	2"	¾" or 1"	w/ upper guide bracket	No	47
SRCH200	62170825	2"	¾" or 1"	w/ upper guide bracket	No	45
SRC300	62170806	3"	¾", 1" or 1¼"	w/ upper guide bracket	No	71
SRCH300	62170826	3"	¾", 1" or 1¼"	w/ upper guide bracket	No	70
SRC4	62170801	4"	1½"	w/ upper guide bracket	No	117
SRC4-SS	62510707	4"	1½"	w/ upper guide bracket	No	-
SRC6	62170802	6"	2"	w/ upper guide bracket	No	180
SRC6-SS	62510707B	6"	2"	w/ upper guide bracket	No	-
SRC8	62170807	8"	3"	w/ upper guide bracket	No	301
SRC3-4-FA	62170817D	3" & 4"	-	flygt adapter w/ SS hardware and gasket	No	36
SRC4-FA	62170817	4"	-	flygt adapter w/ SS hardware and gasket	No	36
SRC6-FA	62170816	6"	-	flygt adapter	No	42
SRC8-FA	62170813	6"	-	flygt adapter w/ SS hardware and gasket	No	42

Spare Parts

Model	Part no.	Description
SRC4- MOV CPL	03010025	Movable coupling
SRC4-O-RING	92010053	O-ring
SRC4-GASKET	92010156	Gasket
SRC6- MOV CPL	03010029	Movable coupling
SRC6-O-RING	92010054	O-ring
SRC6-GASKET	92010159	Gasket

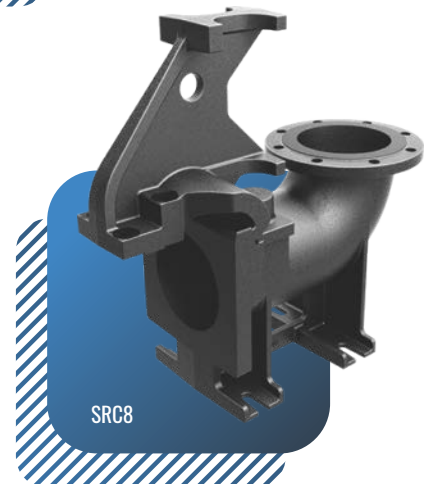
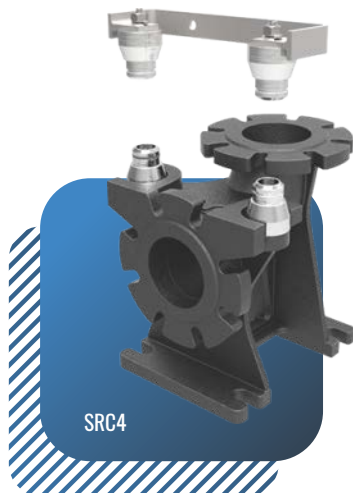

Intermediate Guide Brackets

Model
BPIB-075 for SRC125-SRC300 (include H models)
BPIB-100 for SRC125-SRC300 (include H models)
BPIB-125 for SRC125-SRC300 (include H models)
BPIB-4 for SRC4 4" elbow 9" on center spacing
BPIB-6 for SRC6 6" elbow 12" on center spacing
BPIB-8 for SRC8 8" elbow 4.75" on center spacing

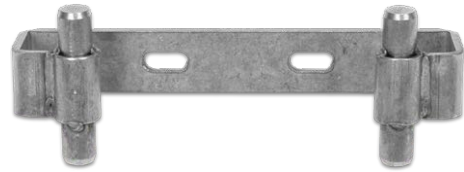

Upper Guide Brackets

Model
BPUB SRC-4 SS
BPUB SRC-6 SS
BPUBS SRC125-SRC300 (include H models)
BPUB300 (include H models)
BPUB SQM SS



Gaskets

Model
BP-GASK3
BP-GASK4
BP-GASK6
BP-GASK8
BPPG400 FULL FACE GASKET FLYGT 4"
BPPG600 FULL FACE GASKET FLYGT 4"



Chain Kits

Model
BPPSS316k-10
BPPSS316k-20
BPPSS316k-30
BPSS14k-10
BPSS14k-20
BPSS14k-30
BPSS516k-10
BPSS516k-20
BPSS516k-30
BPSS38k-10
BPSS38k-20
BPSS38k-30



Hardware Kits

Model
BPPK300 - Included Studs Lock Washers Nuts 3" Gasket
BPPK400 Included Studs Lock Washers Nuts 4" Gasket
BPPK600 Included Studs Lock Washers Nuts 6" Gasket
BPPK800 Included Studs Lock Washers Nuts 8" Gasket



Chain Grabber

Model
BPGRAB - used in lifting and lowering pumps 1/8" - 3/8"
BPGRABmini - same as above. 3/16" - 3/8"



Model	Part no.	Description	Volts	Max. Pump Running Amps	Max. Pump Starting Amps
-------	----------	-------------	-------	------------------------	-------------------------

250 VAC - 50/60 Hz

BPSJT	32010203	20 ft w/ piggy-back plug	250	16 (4)	48
-------	----------	--------------------------	-----	--------	----

0.75 HP @ 120 VAC & 2 HP @ 230 VAC - 50/60 Hz

BP15PMPD1WP	32010251A	15 ft w/ piggy-back plug	120	15	85
BP15PMPD2WP	32010251B	15 ft w/ piggy-back plug	230	15	85
BP20PMPD1WP	32010252A	20 ft w/ piggy-back plug	120	15	85
BP20PMPD2WP	32010251C	20 ft w/ piggy-back plug	230	15	85
BP30PMPD1WP	32010251Z	30 ft w/ piggy-back plug	120	15	85
BP30PMPD2WP	32010251D	30 ft w/ piggy-back plug	230	15	85
BP50PMPD2WP	32010251E	50 ft w/ piggy-back plug	230	15	85
BP15PMPDWOP	32010251F	15 ft, without plug	120/230	15	85
BP20PMPDWOP	32010251G	20 ft, without plug	120/230	15	85
BP30PMPDWOP	32010251H	30 ft, without plug	120/230	15	85

0.5 HP @ 120 VAC - 50/60 Hz

BP15PMS PDT	32010251I	10 ft, pipe mounted	120	13	85
BP20PMS PDT	32010251J	20 ft, pipe mounted	120	13	85

Pipe mounted & weighted - 50/60 Hz

BP15SGMSPDTWE	32010251K	15 ft, w/ weight	120/230	5	85
BP20SGMSPDTWE	32010251L	20 ft, w/ weight	120/230	5	85
BP30SGMSPDTWE	32010251M	30 ft, w/ weight	120/230	5	85
BP50SGMSPDTWE	32010251N	50 ft, w/ weight	120/230	5	85
BP15SGMSPDTPC	32010251O	15 ft, w/ clamp	120/230	5	85
BP20SGMSPDTPC	32010251P	20 ft, w/ clamp	120/230	5	85
BP30SGMSPDTPC	32010251Q	30 ft, w/ clamp	120/230	5	85
BP50SGMSPDTPC	32010251R	50 ft, w/ clamp	120/230	5	85

0.5 HP @ 120 VAC - 50/60 Hz

BP10VM1WP	32010251S	10 ft	120	13	60
BP15VM1WP	32010251T	15 ft	120	13	60
BP20VM1WP	32010251U	20 ft	120	13	60
BP113647	32010251V	10 ft	120	13	60
BP512041	32010251W	20 ft	120	13	60
BP512041A	32010251X	30 ft	120	13	60
BP100829	32010251Y	15 ft	120	13	60



Model	Type	Voltage	Phase	FLA Range	Enclosure Size
BP11S4XNM020	Simplex	115	1	20 max.	12x10x6
BP21S4XNM020	Simplex	208/230	1	20 max.	14x12x6
BP21S4XNM040	Simplex	208/230	1	40 max.	14x12x6
BP11D4XNM020	Duplex	115	1	20 max.	16x14x8
BP21D4XNM020	Duplex	208/230	1	20 max.	16x14x8
BP21D4XNM040	Duplex	208/230	1	40 max.	16x14x8
BP21CS4XNM020	Simplex	208/230	1	20 max.	16x14x8
BP21CS4XNM040	Simplex	208/230	1	40 max.	16x14x8
BP21CD4XNM020	Duplex	208/230	1	20 max.	20x16x8
BP21CD4XNM040	Duplex	208/230	1	40 max.	20x16x8
BPOL21CS4XNM020	Simplex	208/230	1	20 max.	16x14x8
BPOL21CS4XNM040	Simplex	208/230	1	40 max.	16x14x8
BPOL21CD4XNM020	Duplex	208/230	1	20 max.	24x20x12
BPOL21CD4XNM040	Duplex	208/230	1	40 max.	24x20x12
BP43S4XNM004	Simplex	208/230/460	3	2.5 - 4	16x14x8
BP43S4XNM006	Simplex	208/230/460	3	4 - 6.3	16x14x8
BP43S4XNM010	Simplex	208/230/460	3	6 - 10	16x14x8
BP43S4XNM014	Simplex	208/230/460	3	9 - 14	16x14x8
BP43S4XNM018	Simplex	208/230/460	3	13 - 18	16x14x8
BP43S4XNM023	Simplex	208/230/460	3	17 - 23	16x14x8
BP43S4XNM025	Simplex	208/230/460	3	20 - 25	16x14x8
BP43S4XNM032	Simplex	208/230/460	3	24 - 32	16x14x8
BP43S4XNM040	Simplex	208/230/460	3	30 - 40	18x16x10
BP43D4XNM004	Duplex	208/230/460	3	2.5 - 4	20x16x8
BP43D4XNM006	Duplex	208/230/460	3	4 - 6.3	20x16x8
BP43D4XNM010	Duplex	208/230/460	3	6 - 10	20x16x8
BP43D4XNM014	Duplex	208/230/460	3	9 - 14	20x16x8
BP43D4XNM018	Duplex	208/230/460	3	13 - 18	20x16x8
BP43D4XNM023	Duplex	208/230/460	3	17 - 23	24x20x12
BP43D4XNM025	Duplex	208/230/460	3	20 - 25	24x20x12
BP43D4XNM032	Duplex	208/230/460	3	24 - 32	24x20x12
BP43D4XNM040	Duplex	208/230/460	3	30 - 40	24x20x12



SIMPLEX 1 PH
115/220/230 V



DUPLEX 3 PH
115/200/230 V



DUPLEX 3 PH
460 V

For KTM, KAG & KMUD Pumps

Model	Type	Voltage	Phase	FLA Range	Enclosure Size
BPK004	Simplex	208/230/460	3	2.5 - 4	10x8x6
BPK006	Simplex	208/230/460	3	4 - 6.3	10x8x6
BPK010	Simplex	208/230/460	3	6 - 10	10x8x6
BPK014	Simplex	208/230/460	3	9 - 14	10x8x6
BPK018	Simplex	208/230/460	3	13 - 18	10x8x6
BPK023	Simplex	208/230/460	3	17 - 23	10x8x6
BPK025	Simplex	208/230/460	3	20 - 25	10x8x6
BPK032	Simplex	208/230/460	3	24 - 32	10x8x6
BPK004A	Simplex	208/230/460	3	2.5 - 4	14x12x6
BPK006A	Simplex	208/230/460	3	4 - 6.3	14x12x6
BPK010A	Simplex	208/230/460	3	6 - 10	14x12x6
BPK014A	Simplex	208/230/460	3	9 - 14	14x12x6
BPK018A	Simplex	208/230/460	3	13 - 18	14x12x6
BPK023A	Simplex	208/230/460	3	17 - 23	14x12x6
BPK025A	Simplex	208/230/460	3	20 - 25	14x12x6
BPK032A	Simplex	208/230/460	3	24 - 32	14x12x6

• A = Automatic controller



Control Panel Accessories

Model	Description
C1	Adder for ELAPSED TIME METER (price per meter)
C2	Adder for CYCLE COUNTER (price per counter)
LA1	Adder for Single Phase LIGHTNING ARRESTOR
LA3	Adder for 3 Phase LIGHTNING ARRESTOR
PM	Adder for 3 Phase POWER MONITOR RELAY
VM	Adder for Single Phase VOLTAGE MONITOR
AX	Adder for AUX CONTACTS NORMALLY OPEN (price per contact)
H1	Adder for LARGER HORN

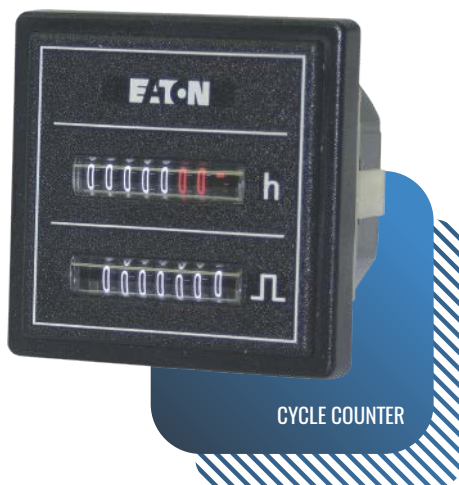

Model	Part no.	Description
3BSE-SS-OHK	-	Overhaul kit for 1.5, 2 & 3 HP
4BSE-DS-OHK	31075204	Overhaul kit
4BSE-DS-SK	31075223	Seal kit
4BSE-SS-OHK	31075203	Overhaul kit
6BSE-(H)LDS-OHK	31075209	Overhaul kit
6BSE-SK	31075215	Seal kit
BGP-DS-OHK	31075206	Overhaul kit for 3, 5 & 7.5 HP
BGP-DS-CTK	31075217	Cutter kit for 3, 5 & 7.5 HP
BGP-DS-SK	31075226	Seal kit for 3, 5 & 7.5 HP
BGPH-DS-CK	31073221	Convert kit to horizontal discharge for 3, 5 & 7.5 HP
SH3-CVK	-	Check valve
SH3-WPK	-	Wear plate
SH3-SK	31075232C	Seal kit
SH4-CVK	31075168	Check valve
SH4-WPK	31075168B	Wear plate
SH4-SK	31075232D	Seal kit
SH6-CVK	31075169	Check valve
SH6-WPK	31075169B	Wear plate
SH6-SK	31075232E	Seal kit
SH8-CVK	31075170	Check valve
SH8-WPK	31075170B	Wear plate
SH8-SK	31075232F	Seal kit
3, 4, 5 CCE-SK	31075115B	Seal kit
10 CCE-SK	31075115	Seal kit
15, 20, 25 CCE-SK	31075252	Seal kit
3, 4, 5 & 10 CCE-CVK	31070135	Check valve
15, 20, 25 CCE-CVK	31070136	Check valve

We manufacture pumps and integrated pumping equipment, pioneers in the market with 70 years of experience. Our products cover commercial, municipal, sewage, industrial, chemical, rain, drinking water, construction, irrigation, flood control, fire fighting equipment, power plants and many more.



Toll Free USA
1-844-BARMESA (227-6372)



contact@barmesapumps.com



barmesapumps.com/US

